



Oil Injection Kit

Part# AB-21183-20

Fits 2020+ 250/300 RR Race Editions



SAFETY/ATTENTION Failure to respect information marked with this symbol can entail a personal hazard/



Read the use and maintenance manual carefully



Read the workshop manual carefully



Grease



Threadlocker Medium-resistance



Silicone/ Silicone/ Silicone/ Silikon/



Value Fastening torque



Oil Injection Kit

Part# AB-21183-20

Fits 2020+ 250/300 RR Race Editions

To install the kit, you must remove:

The air filter, as described in the operating and maintenance manual



Perform the rotation procedure of the air filter box, as described in the motor workshop manual, in order to remove the carburettor and intake sleeve.



Preparing the intake system and filter box

1) Replace the intake sleeve with the one **1** provided with the kit. Refer to the motor workshop manual for the instructions.

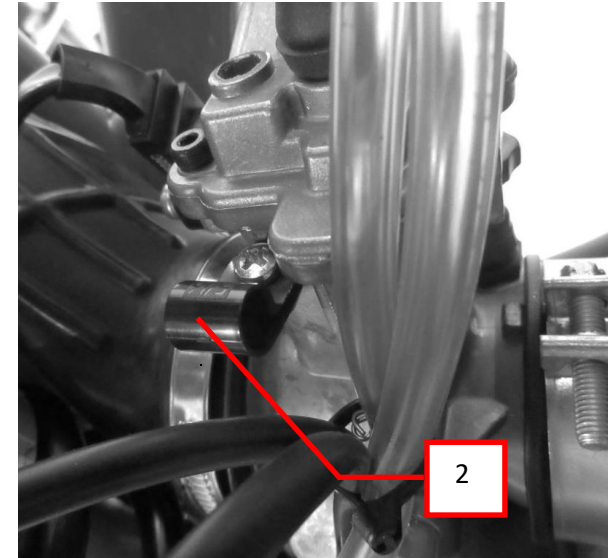
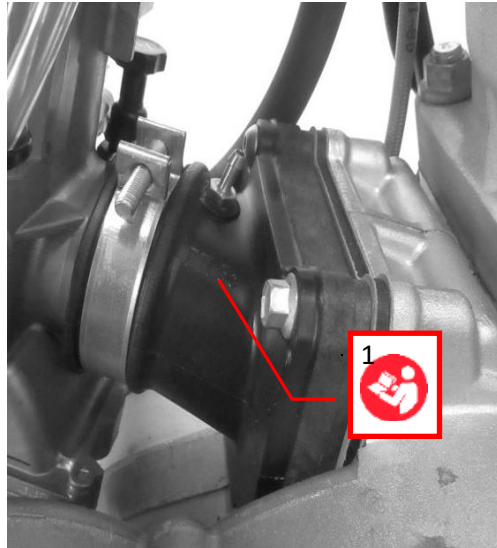

2) Connect the cable gland **2** to the carburettor and put the carburettor back in place.

3) Using a 11mm drill bit, make a hole in the area indicated, where the pre-cut breakoff is. Apply the tube hold **3** provided with the kit

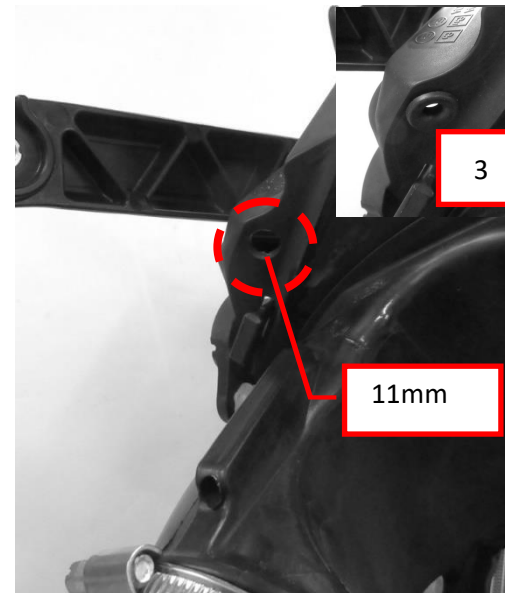



Oil Injection Kit

Part# AB-21183-20

Fits 2020+ 250/300 RR Race Editions

- 1) Remove screws **1** and **2** that secure the plate holder to the vehicle;
- 2) Remove screws **3** and **4** (one per side) that secure the mudguard to the vehicle
- 3) Hold the mudguard by the sides, widen the mudguard and push backwards

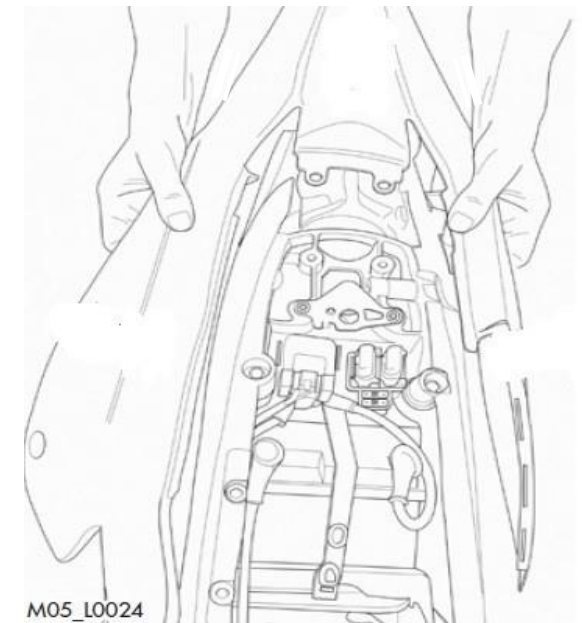
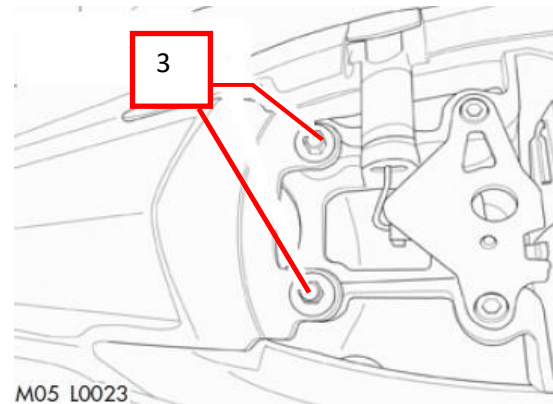
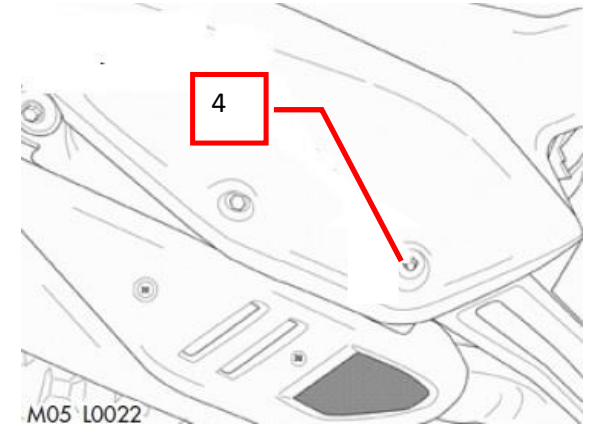
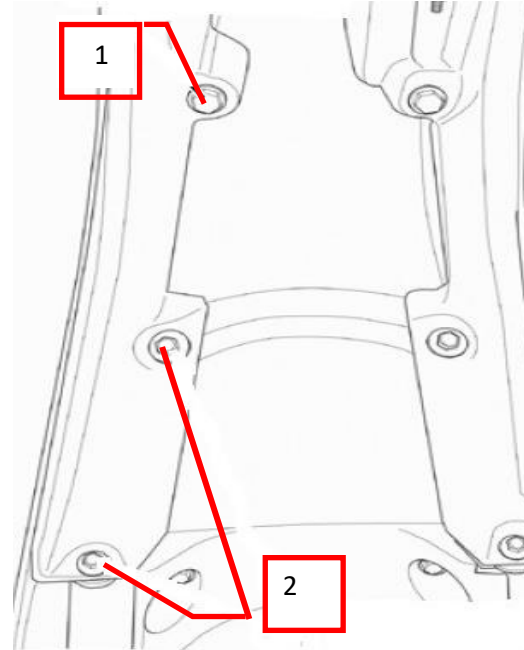



Oil Injection Kit

Part# AB-21183-20

Fits 2020+ 250/300 RR Race Editions

Removing the filter box uprights

1) Remove the rubber buffers **1**

2) Remove screws **2** and **3**

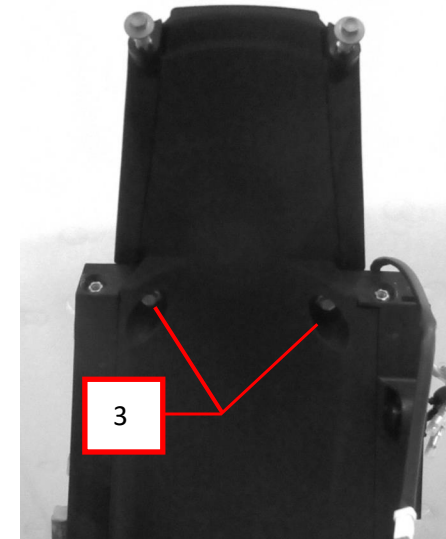
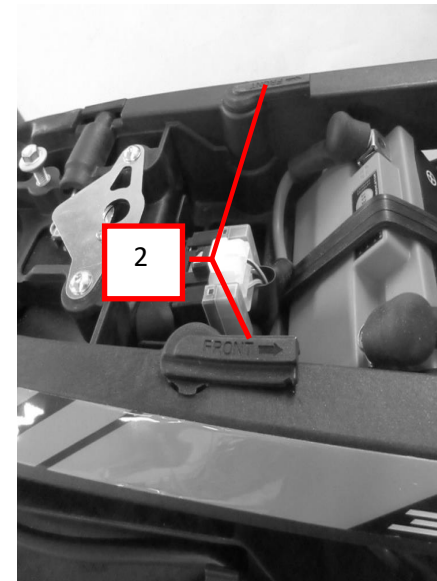
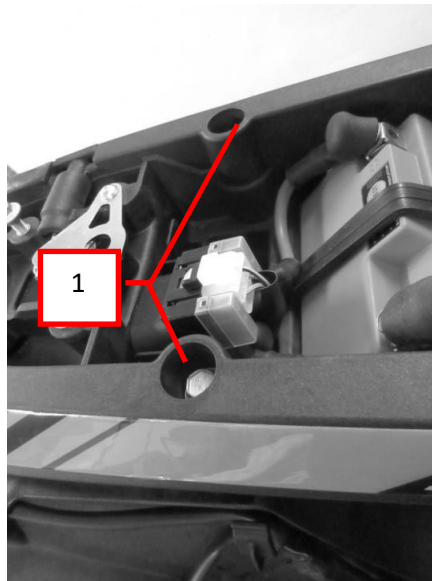



Oil Injection Kit

Part# AB-21183-20

Fits 2020+ 250/300 RR Race Editions

3) Release the connector
A

4) Remove the screw **4**
(one per side) between
the upright and inner tie
rod

5) Release the uprights
from the filter box

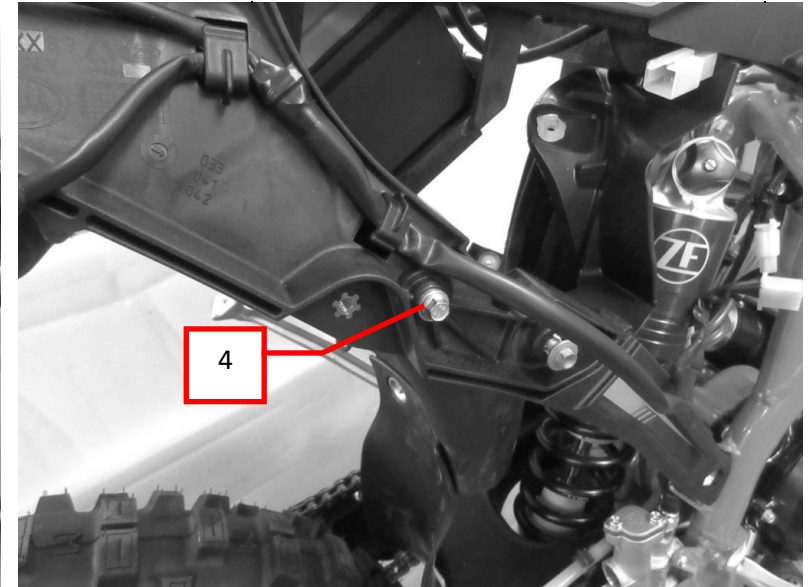
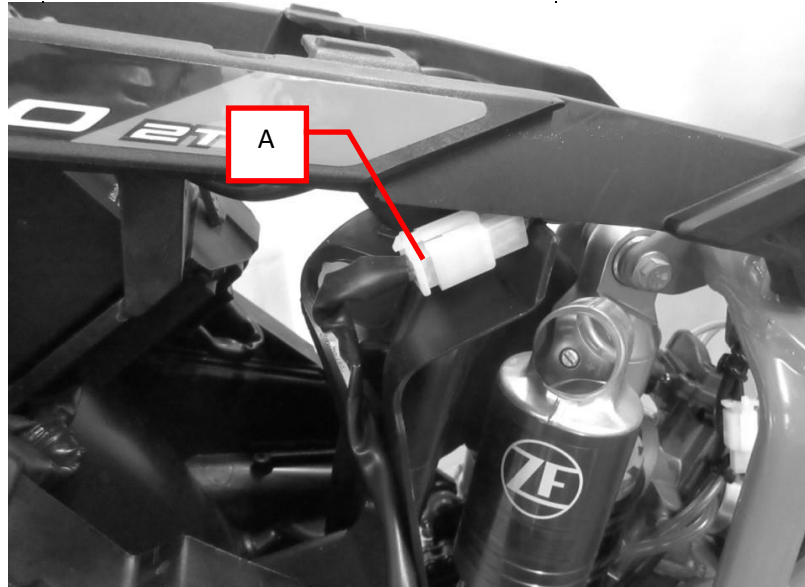



Oil Injection Kit

Part# AB-21183-20

Fits 2020+ 250/300 RR Race Editions

Assembling the complete oil tank

1) Free the wiring 1

2) Remove the resistance 2

3) Apply the spacers 3
provided with the kit

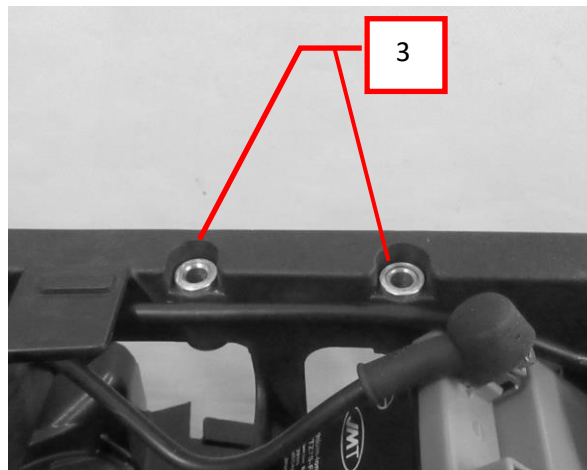
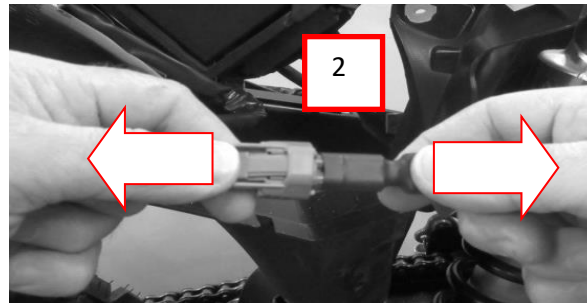
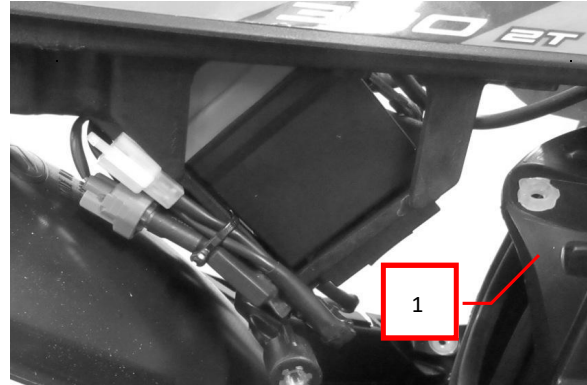



Oil Injection Kit

Part# AB-21183-20

Fits 2020+ 250/300 RR Race Editions

4) Fit the complete oil tank unit provided with the kit, as shown

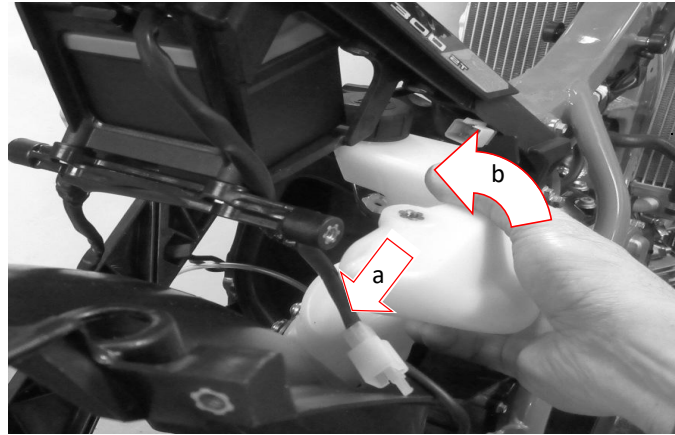

5) Apply the screws 4 as indicated. Make sure the cable gland is positioned correctly. Tighten at the specified torque

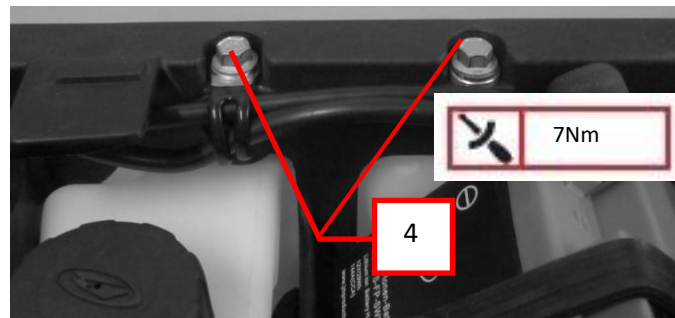
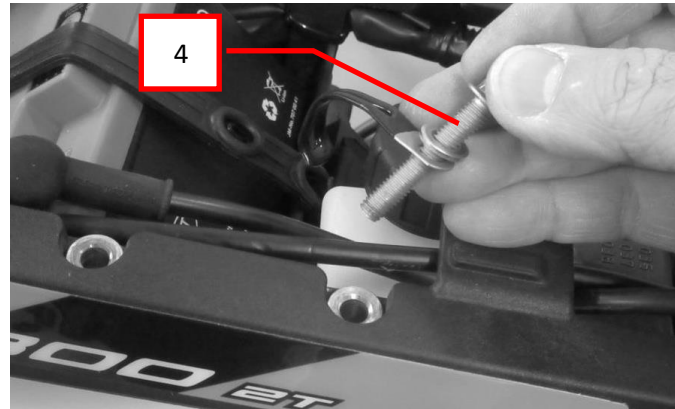



Oil Injection Kit

Part# AB-21183-20

Fits 2020+ 250/300 RR Race Editions

6) Connect connectors **5** and **6** to the tank unit and secure the wiring with the appropriate clamp **7**

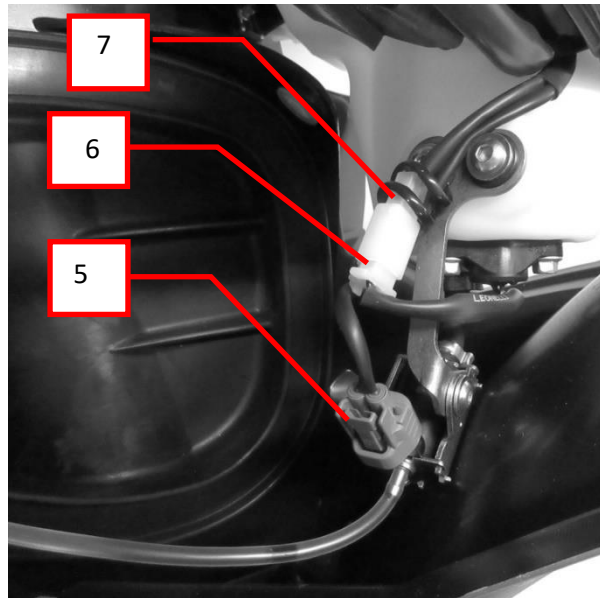

7) Insert the oil pipe into the tube hold **8** and sleeve **9**

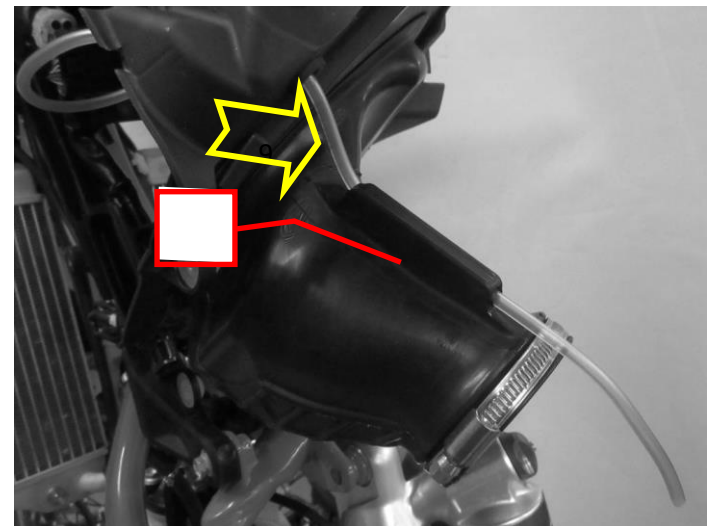
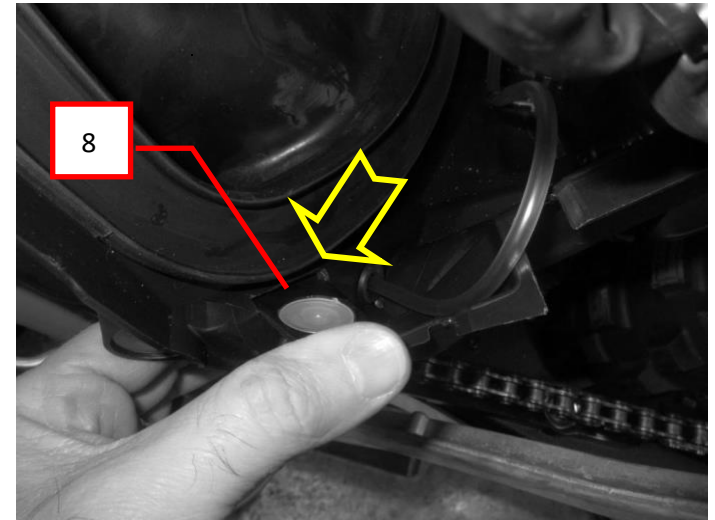



Oil Injection Kit

Part# AB-21183-20

Fits 2020+ 250/300 RR Race Editions

Reassembling the uprights/filter box and complete assembly of the mixing unit

1) Reassemble the left and right uprights, making sure the filter box is inserted correctly in the respective slots on the uprights. Apply the screw **1** (one per side) and tighten at the specified torque

2) Reconnect the connector **2**

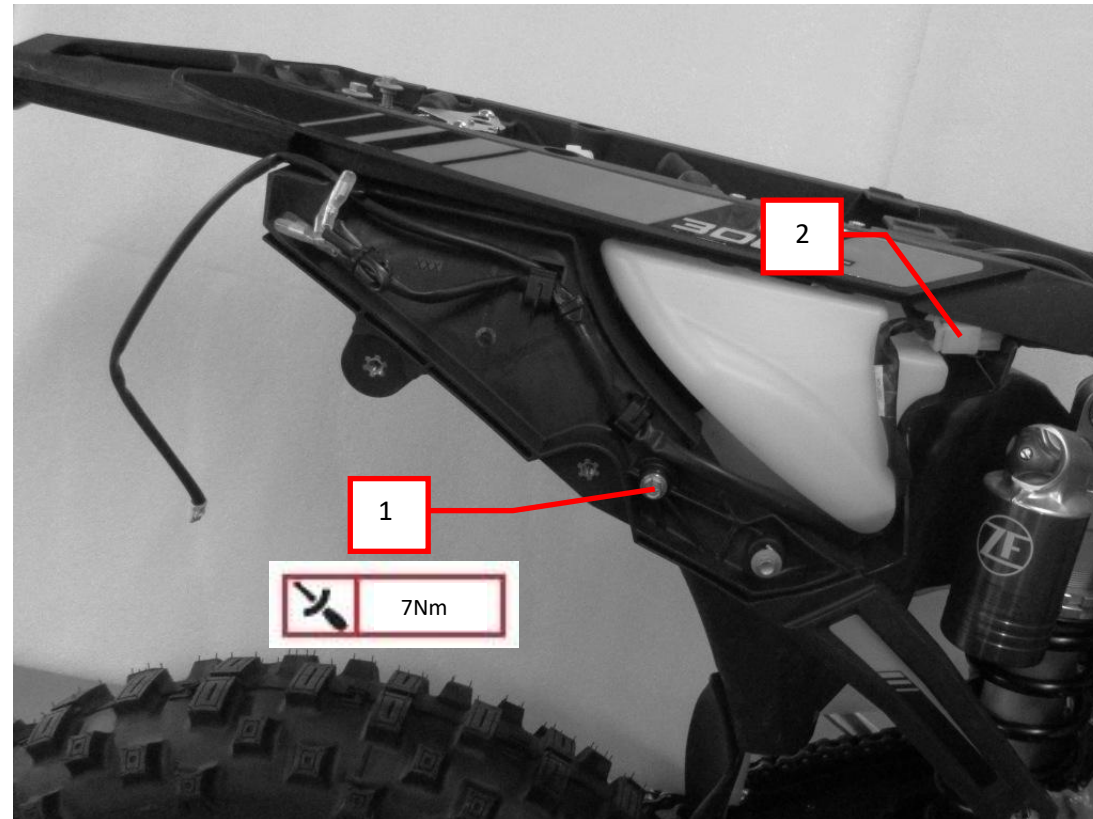



Oil Injection Kit

Part# AB-21183-20

Fits 2020+ 250/300 RR Race Editions

3) Apply the screws 3 and 4.
Tighten at the specified torque

4) Reassemble the buffers 5
as shown in the figure

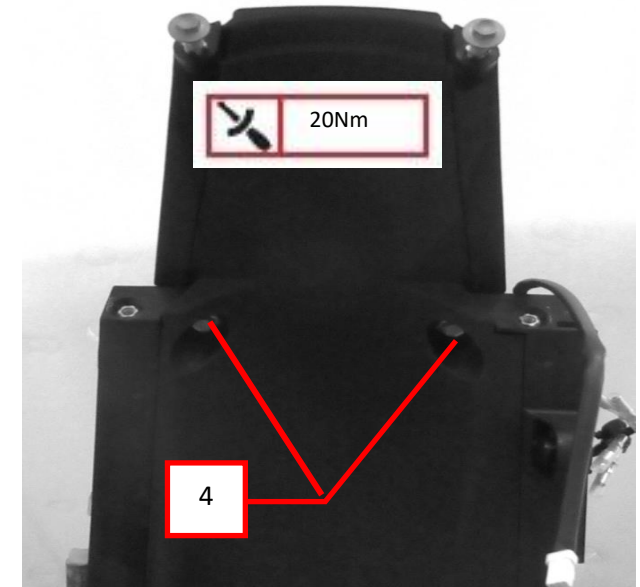
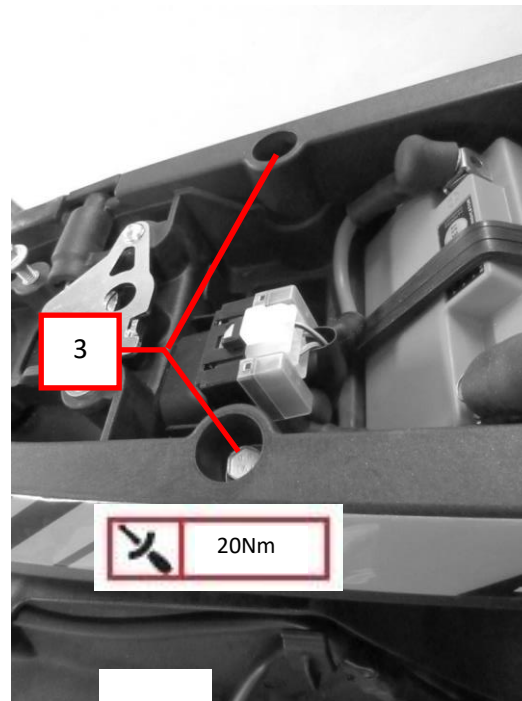



Oil Injection Kit

Part# AB-21183-20

Fits 2020+ 250/300 RR Race Editions

5) Insert the oil pipe in the tube hold 6

6) Make sure the filter box sleeve is inserted correctly onto the carburettor and tighten the relevant clamp

7) Insert the oil pipe in the intake manifold nozzle.

8) Apply silicone to the incisions on the filter box and insert the oil pipe

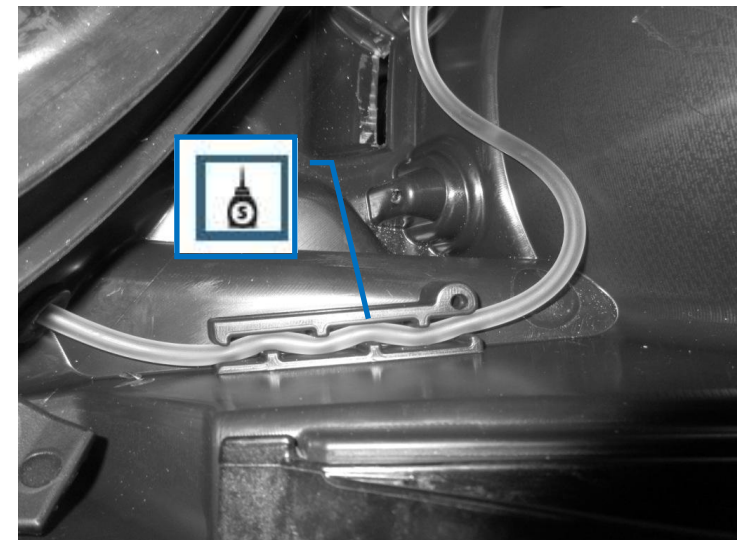
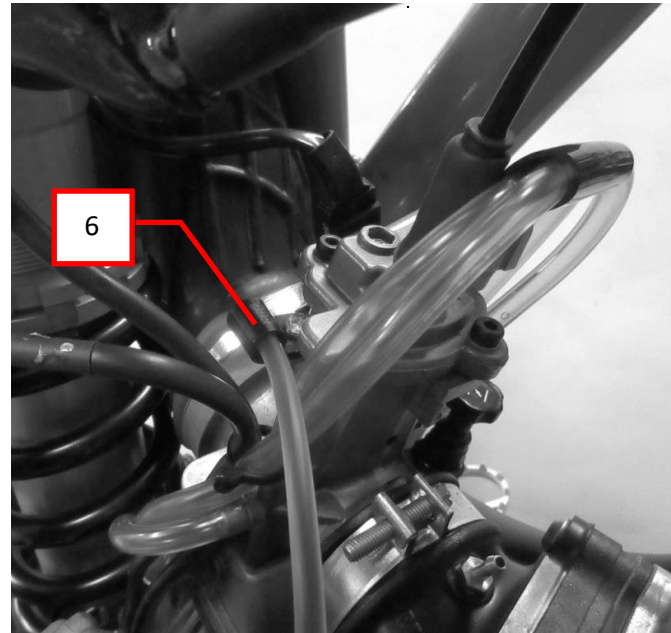



Oil Injection Kit

Part# AB-21183-20

Fits 2020+ 250/300 RR Race Editions

1) Hold the mudguard by the sides, widen the mudguard and push forward

2) Apply the screws **1** and **2** (one per side) that secure the mudguard to the vehicle

3) Apply the screws **3** and **4** fastening the plate holder to the vehicle

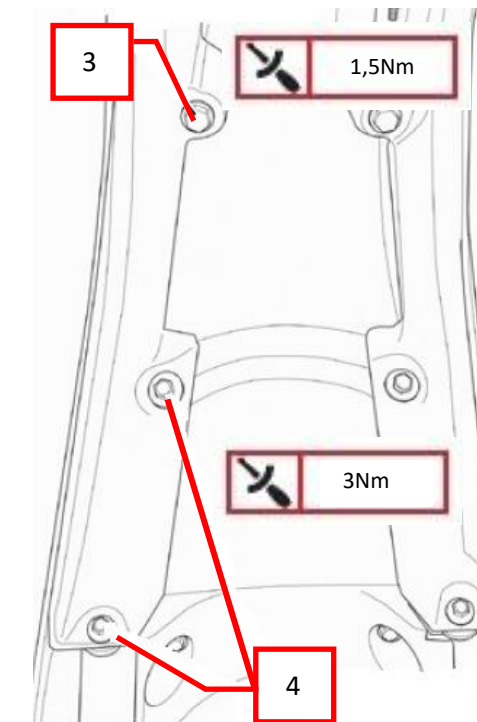
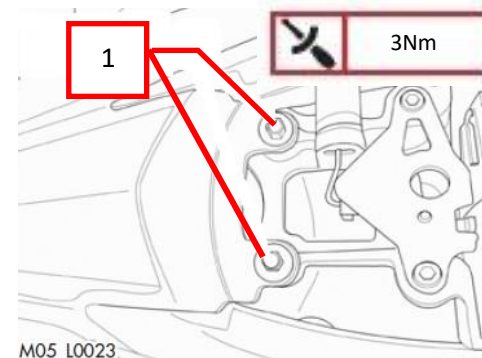
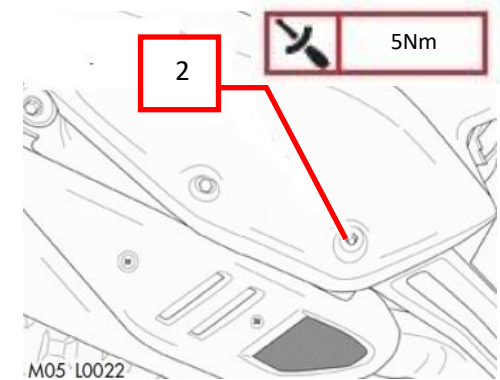
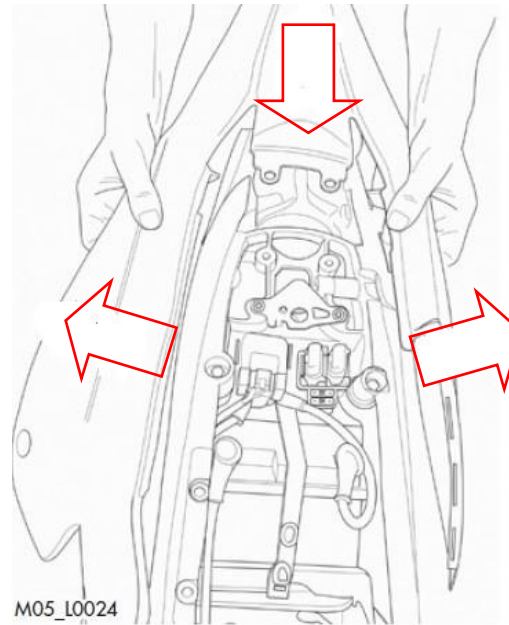



Oil Injection Kit

Part# AB-21183-20

Fits 2020+ 250/300 RR Race Editions

Final operations



1) Complete the assembly by applying the screws of the filter box uprights/frame, as shown in the workshop manual.



2) Apply the tank as shown in the workshop manual



3) Apply the exhaust expansion and silencer as shown in the motor workshop manual



4) Apply the air filter, air filter cover and seat as described in the operating and maintenance manual.



5) Fill the tank with oil, as described in the operating and maintenance manual.



ATTENTION! Empty the fuel tank and fill with approximately 5L of petrol and oil 1.6% mixture.



Start the engine and make sure the mixer oil pipe fills completely. After making sure the mixing circuit works correctly, subsequent fuel top-ups must be carried out with petrol. Refer to the operating and maintenance manual for information regarding the type of oil and petrol to use.