



Beta
the play bike

BETAMOTOR.COM

EVO
2012 evolution *trial* 

4T



MANUALE DI ISTRUZIONI
OWNER'S MANUAL
MANUAL DE ISTRUCCIONES
MANUEL D'INSTRUCTIONS
BEDIENUNGSANLEITUNG

EVO 4T 2012
250-300

CAUTION

It is important, after the first hour of break-in, to check the tightness of all fasteners, paying particular attention to the following:

- Footrest brackets
- Front and rear brake discs
- Wheel spokes
- Shock absorber bolt and rear linkage
- Engine bolts
- Rear sprocket
- Exhaust bolts

Index

Pag.

CHAPTER 1: GENERAL INFORMATION

INDEX OF TOPICS

Main parts.....	46
Vehicle identification details.....	46
Engine identification details.....	46
Console and controls.....	46
Technical details.....	47
Wiring scheme.....	48

CHAPTER 2: Operation and Use

INDEX OF TOPICS

Filling the fuel tank.....	50
Start-up	50
Advance map change switch	51
Break-in	52
Checks and maintenance before and after off-road use	52
Recommended lubricants and liquids.....	53

CHAPTER 3: MAINTENANCE AND CHECKS

INDEX OF TOPICS

Lubrication circuit.....	55
Engine oil.....	56
Brake master cylinder fluid.....	59
Brakes circuit bleeding	60
Clutch master cylinder fluid	62
Clutch circuit bleeding.....	62
Fork oil	63
Sparkplug	64
Air filter	65
Ignition generator check	66
Front brake	67
Rear brake	68
Coolant	69
Rear suspension linkage	70
Checks after cleaning	70
Scheduled maintenance	71

CHAPTER 4: ADJUSTMENTS

INDEX OF TOPICS

Brake adjustment	73
Clutch adjustment	73
Carburettor	74
Tickover adjustment	74
Throttle free clearance adjustment	74
Checking and adjusting steering clearance	74
Chain tension	75
Front suspension adjustment	76
Rear shockabsorber adjustment	76

CHAPTER 5: WHAT TO DO IN AN EMERGENCY

INDEX OF TOPICS

Troubleshooting.....	78
----------------------	----



Chapter 1

General information

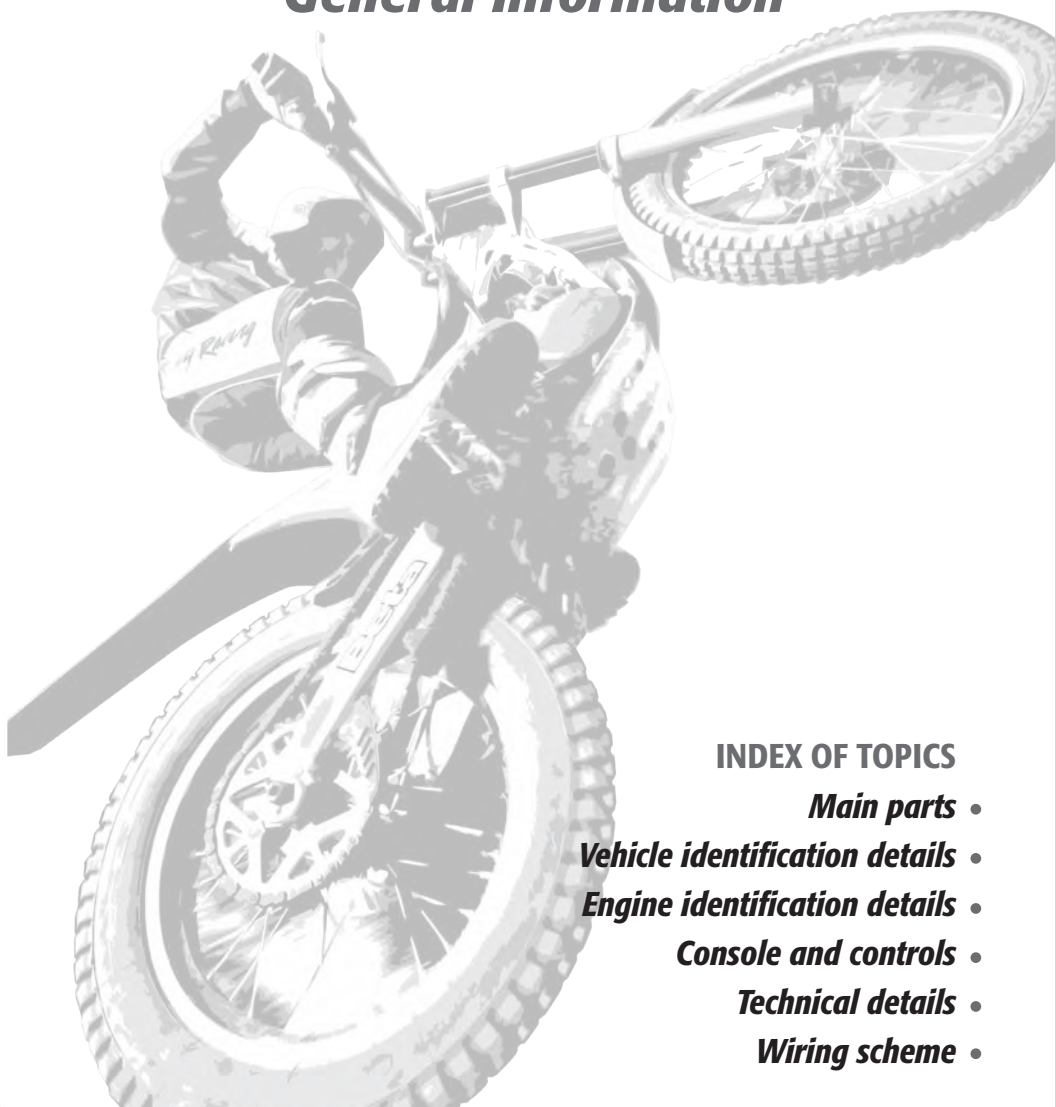

INDEX OF TOPICS

- Main parts •***
- Vehicle identification details •***
- Engine identification details •***
- Console and controls •***
- Technical details •***
- Wiring scheme •***

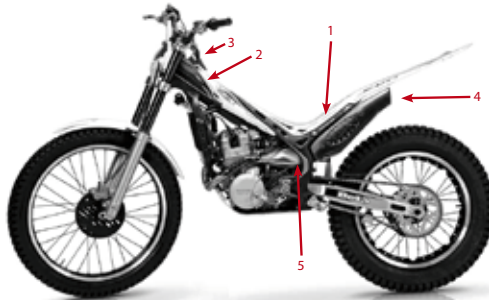

MAIN PARTS

- 1 - Filter box 2 - Fuel tank 3 - Fuel filler cap
4 - Silencer 5 - Kickstart lever

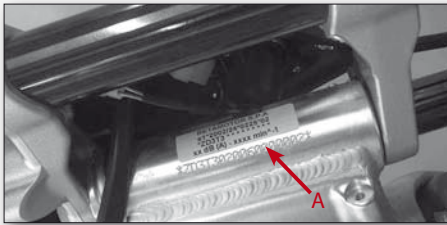

VEHICLE IDENTIFICATION DETAILS

Frame identification.

The frame identification details (A) are stamped on the right-hand side of the headstock.

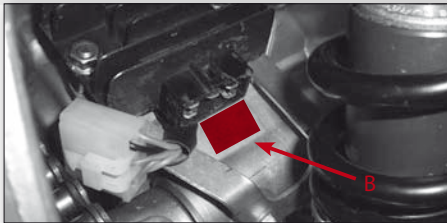

ENGINE IDENTIFICATION DETAILS

Engine identification data B is stamped in the area shown in the figure. In order to read it correctly, it is necessary to remove the silencer and disconnect the regulator connector.

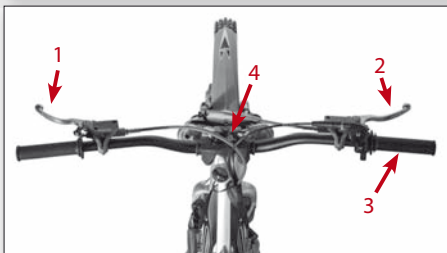

CONSOLE AND CONTROLS

- 1 Clutch lever
2 Front brake lever
3 Throttle twistgrip



- 4 Tasto spegnimento motore
5 Tasto accensione/spegnimento fari

TECHNICAL DETAILS**Vehicle weight**

- in running order (dry) 72 kg

Dimensions

- overall length 2005 mm

- overall width 850 mm

- overall height 1.115 mm

- wheelbase 1.305 mm

- seat height 660 mm

- ground clearance 310 mm

Tyres

- pressure kPa front 39-44 / rear 29-34

- tyre sizes front 2.75- 21" (Tube Type)

rear 4.00 - 18" (X11Tubeless)

Capacities

- fuel tank 2.5 litres

- cooling circuit 600 cc

- engine oil BARDAHL XT C60 15W50 - 900 cc

Front suspension

- hydraulic forks with 38 mm stanchions, rebound and spring preload adjustment

Fork oil capacities:

- right leg 370 cc

- left leg 350 cc

Rear suspension

- progressive hydraulic monoshock, with rebound and spring preload adjustment

Front and rear brake discs

- disc, with hydraulic control

Engine

- type Single cylinder, 4-stroke, 4 valve head, SOHC. (ZD3E77)

- bore x stroke 77x53,6 mm 250cc - 84x53,6 mm 300 cc

- displacement (cm³) 249.6 - 297

- compression ratio 11.5:1 - 11.4:1

- liquid cooling

- digital electronic ignition with magneto flywheel alternator and variable advance

- starting by kickstart

- sparkplug NGK CR7EB

Fuel system

- carburettor MIKUNI SE BSR 33-79

- jet 127.5-27.5 max-min

- runs on unleaded petrol

WIRING SCHEME

CAUTION: Do not run the engine with the voltage regulator connected to the electrical generator without having connected the vehicle wiring harness (central system). Doing so could cause damage to the regulator itself.

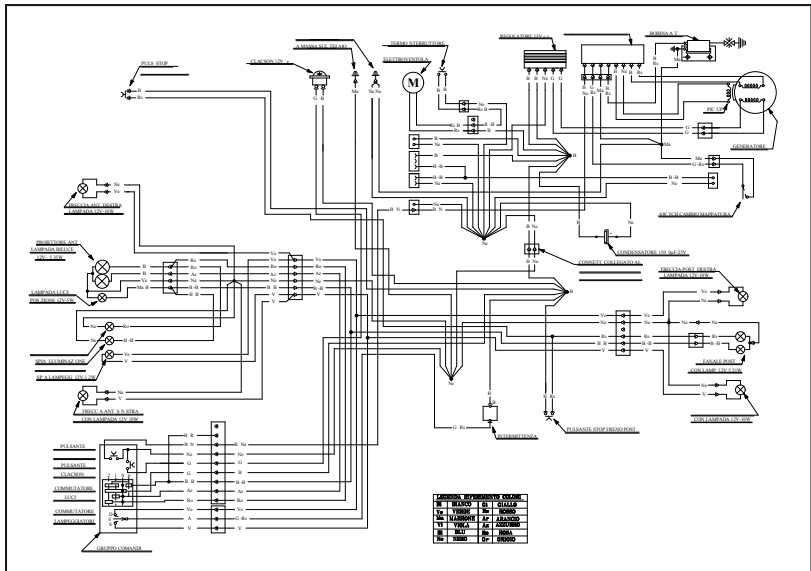
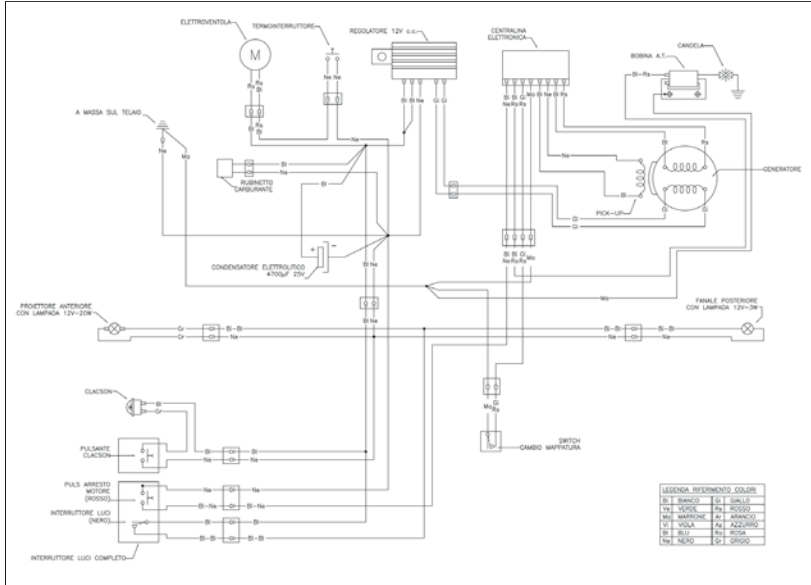

Chapter 2

Operation and Use

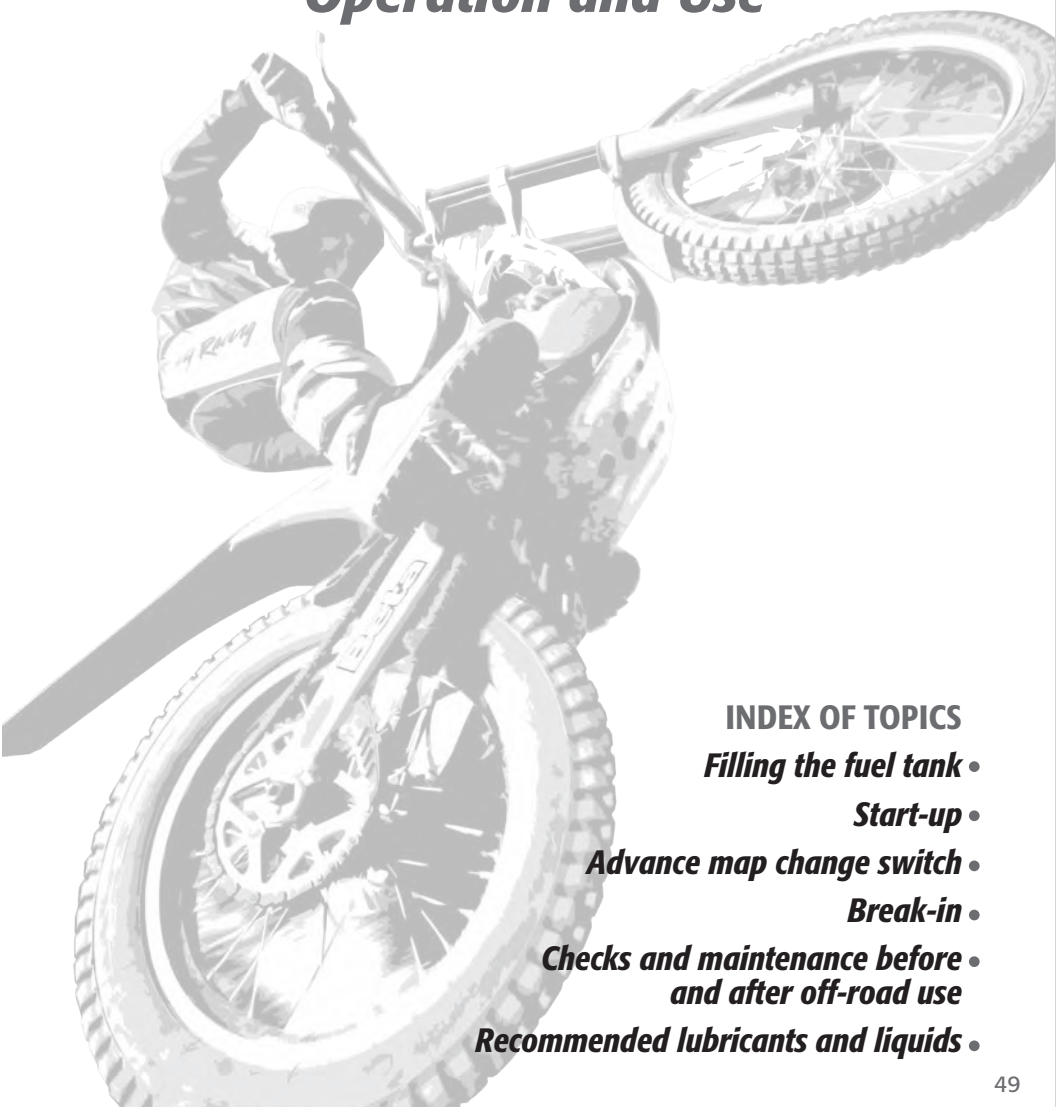

INDEX OF TOPICS

Filling the fuel tank •

Start-up •

Advance map change switch •

Break-in •

***Checks and maintenance before
and after off-road use***

Recommended lubricants and liquids •

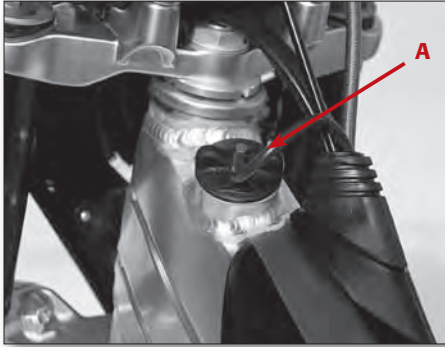

FILLING THE FUEL TANK

Remove filler cap A. The capacity of the fuel tank is approximately 2.5 litres.

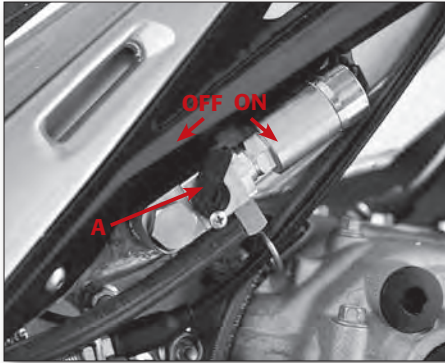

START-UP

- 1 Put the gearbox in neutral.
- 2 WITHOUT opening the throttle, press the kickstart lever progressively downwards, avoiding violent strokes, to the bottom of its travel.

Note

A long period with the engine out of use, such as when the vehicle is on its side, can lead to a lowering of the fuel level in the carburettor float bowl, making the bike hard to start.

in this case open manually the fuel tap by turning the lever A clockwise (ON)

Once the engine has started, **reclose the fuel tap.**

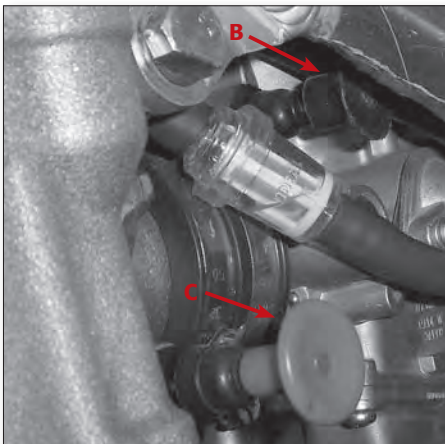

STARTING THE ENGINE FROM COLD

- 1 Put the gearbox in neutral.
- 2 Operate the choke lever B (black knob) by pulling it outwards.
- 3 WITHOUT opening the throttle, press the kickstart lever progressively downwards, avoiding violent strokes, to the bottom of its travel.
- 4 Reclose the choke as soon as the engine has warmed up (the radiator will be warm).

STARTING THE ENGINE WHEN HOT

- 1 Put the gearbox in neutral.
- 2 Operate the hot start by pulling outward the knob C (the red one)
- 3 WITHOUT opening the throttle, press the kickstart lever progressively downwards, avoiding violent strokes, to the bottom of its travel.
- 4 Release the hot start after the engine has run for some instants

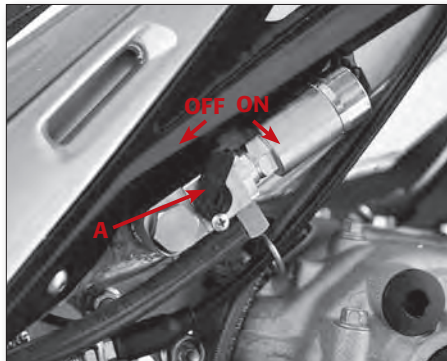

STARTING WHEN THE BIKE HAS FALLEN OVER

If the bike falls over, the carburettor float bowl may empty.

- 1 Open manually the fuel tap by turning the lever A clockwise (ON)
- 2 Put the gearbox in neutral.
- 3 Operate the Hot Start knob (C).
- 4 WITHOUT opening the throttle, press the kickstart lever progressively downwards, avoiding violent strokes, to the bottom of its travel.
- 5 Close the fuel tap.

ADVANCE MAP CHANGE SWITCH

Using the switch shown in the figure, it is possible to choose between two different map for spark advance.

With the switch in position 1, *“soft”* map is selected, more suitable for slippery terrain and for a softer engine response.

With the switch in position 2, *“hard”* map is selected, for a more aggressive engine response: more suitable for dry conditions.

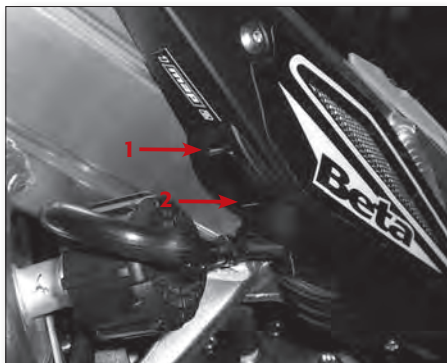

BREAK-IN

The break-in period lasts for about 10 hours of use. During this period, please observe the following recommendations:

- 1 For the first 3 hours of use, the engine should only be used at up to 50% of its power. The engine speed should not exceed 7000 rpm.
- 2 For the next 7 hours of use, the engine should only be used at up to 75% of its power.
- 3 Warm the engine up well before using the bike.
- 4 Avoid travelling at a constant speed: varying the speed makes the components bed in uniformly and in less time.

CAUTION:

After the first three hours (or two fills of petrol), change the engine oil.

- *Always use super unleaded petrol.*
- *After the first trip off-road, check all the nuts and bolts.*

CHECKS AND MAINTENANCE BEFORE AND AFTER OFF-ROAD USE

To avoid unpleasant surprises while operating the vehicle, we recommend that you perform a series of checks and maintenance jobs both before and after use. In fact, dedicating just a few minutes to these checks and jobs will not only make riding safer, but can save you time and money. Proceed as follows:

Tyres

Check the pressure, general condition and tread depth.

Spokes

Check that the tension is correct.

Nuts and bolts

Check the tight of all the nuts and bolts.

Chain

Check the tension (clearance 20 mm) and, if necessary, grease it.

Air filter

Clean the filter and soak it in air filter oil.

Note

Check that you have the vehicle's identification documents. On cold days, before setting off we advise that you run the engine, as a minimum, for the time required to reach the correct operating temperature. Every time the vehicle is used off-road it needs to be cleaned carefully.

RECOMMENDED LUBRICANTS AND LIQUIDS

To promote better operation and longer life, we recommend that you preferably use the products listed in the table:

TYPE OF PRODUCT	TECHNICAL SPECIFICATIONS
Engine oil	Bardahl XT C60 15W50
Brake and clutch fluid	Bardahl brake fluid dot 4
Fork oil	Idemitsu oj-racing-01
	Bel ray "mc 10sae 5"
Grease for linkages	Bardahl outboard grease
Coolant	Bardahl permanent
Filter oil	Bardahl oil filter

Note

When changing the fluids, we recommend that you adhere strictly to the table shown.

Chapter 3

Maintenance and checks

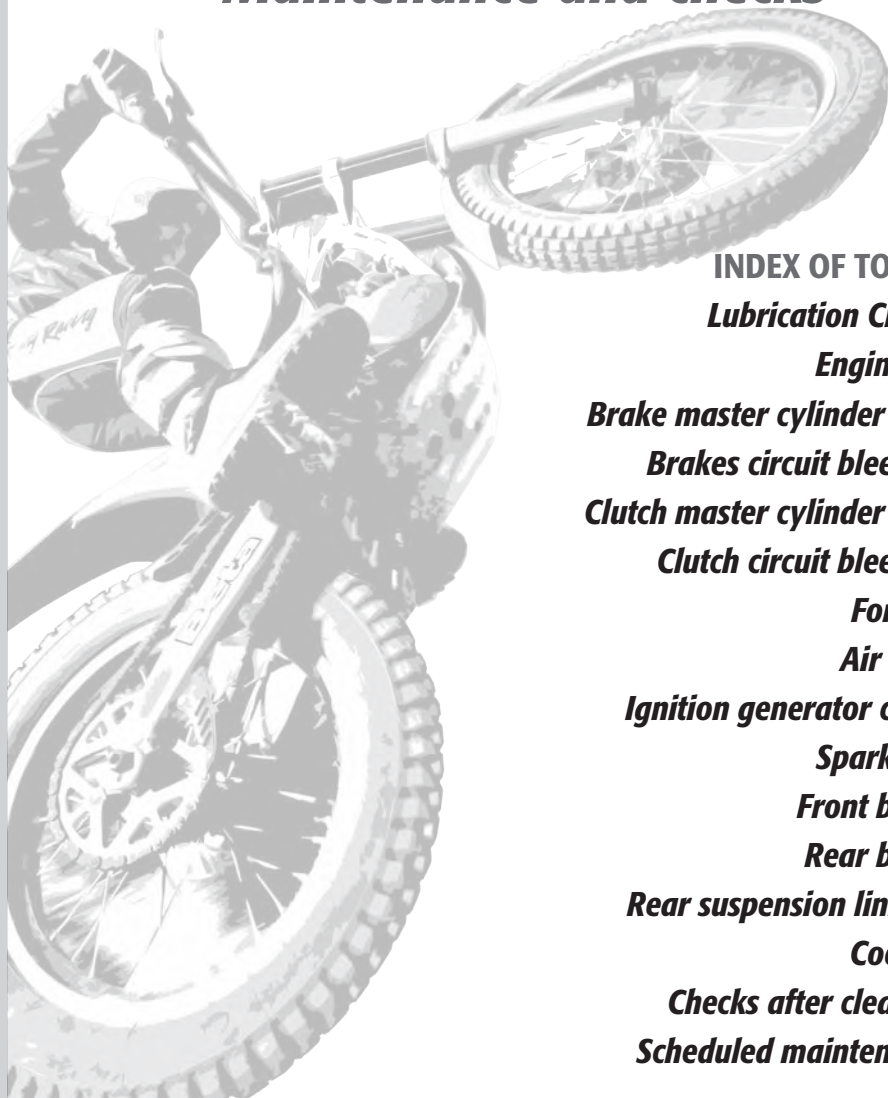

INDEX OF TOPICS

Lubrication Circuit •

Engine Oil •

Brake master cylinder fluid •

Brakes circuit bleeding •

Clutch master cylinder fluid •

Clutch circuit bleeding •

Fork oil •

Air filter •

Ignition generator check •

Sparkplug •

Front brake •

Rear brake •

Rear suspension linkage •

Coolant •

Checks after cleaning •

Scheduled maintenance •

LUBRICATION CIRCUIT

The output oil pump (1) draws in oil from the area at the base of the gearbox through its own mesh oil filter (2) and then sends it to the paper oil filter (3). From here the oil, starting from the bypass valve (4), is directed in three different directions: by means of a jet (5) it lubricates the piston pin and takes heat from the crown of the piston; and it passes through two pipes, one of which (6) takes it to the crankshaft to lubricate the roller bearing on the crankpin; the other (7), whose flow is regulated by a calibrated hole on the cylinder base gasket (8), feeds the valvegear (9). The oil then returns to the base of the crank chamber from the piston, the conrod assembly and the cylinder walls, and is drawn in by the scavenge pump (10) through the mesh filter (11). It is pumped through special jets (12) and lubricates the transmission gears. The oil in the cylinder head, however, returns to the base of the gearbox passing through the timing case and the inner clutch casing.

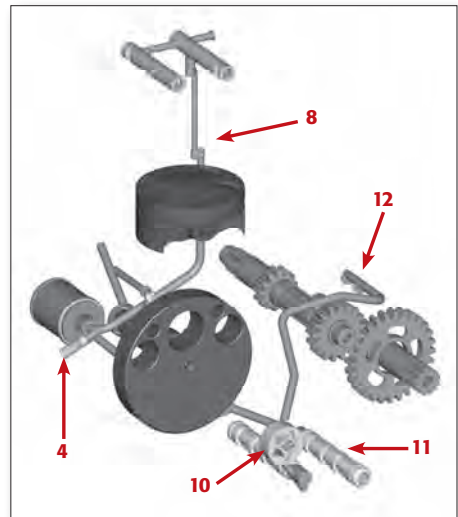
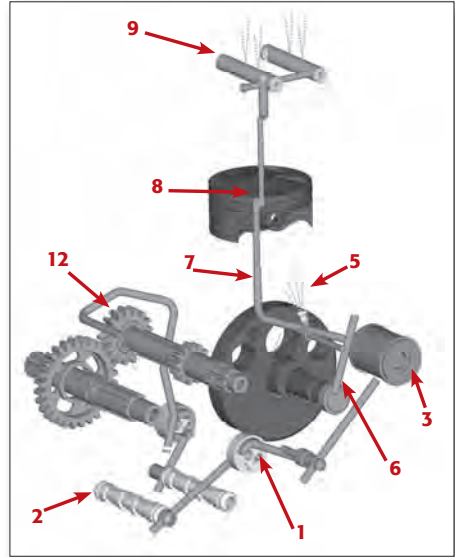



ENGINE OIL

Use only fully synthetic oils of a reliable brand (BARDAHL XTC60 15W50).

CHECKING THE ENGINE OIL LEVEL

The engine oil level must be checked when the engine is warm. Run the engine for several minutes and then switch it off. Place the bike on a flat surface in such a way that it is perfectly vertical.

Wait a few minutes and then check the oil level in the sightglass located in the clutch casing (right-hand side of the engine). The level must be between the limits indicated in the picture.

If necessary, remove the oil filler plug and top up the level.

N.B. Running the engine with too little oil causes excessive wear to the engine components.

CHANGING THE ENGINE OIL

N.B. At each oil change, the mesh filters must be cleaned and the paper filter replaced.

N.B. The oil change must be carried out when the engine is at working temperature. Be careful not to scald yourself with the hot oil.

After the engine has reached operating temperature, switch the bike off and stand it upright.

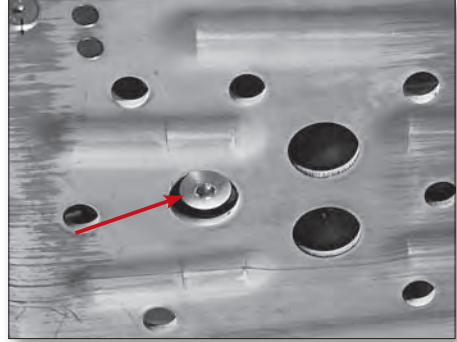

Unscrew the oil drainplug and let all the oil flow out into a drain pan. Thoroughly clean the magnet on the drainplug to get rid of the metallic impurities that it has collected.

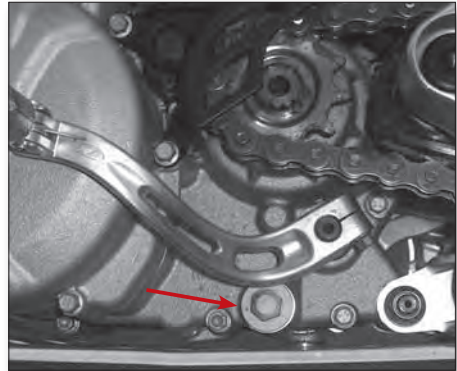

Unscrew the plug in the left-hand casing and use pliers to extract the filter. Clean it carefully and blow it through with compressed air. Check for damage to the O-rings, and replace them if necessary. Refit all the parts and tighten the plug to 15 Nm.



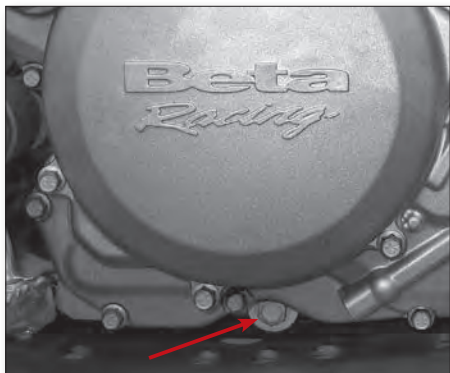

Execute same procedure for the filter located on the right side of crankcase.

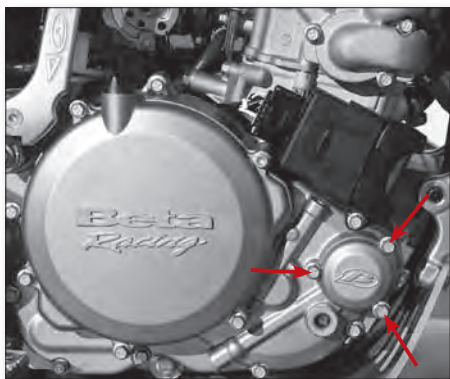
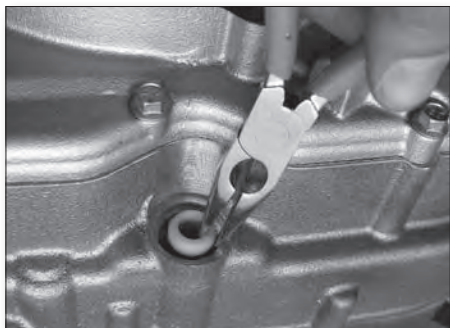

Put a drawn pan under the engine closer to the paper filter cover and then unscrew the cover.

Extract the paper filter using pliers. Check the condition of the O-ring too, and replace it if necessary.

Change the filter and refit the cover, tightening the three M6x20 bolts to 10 Nm.

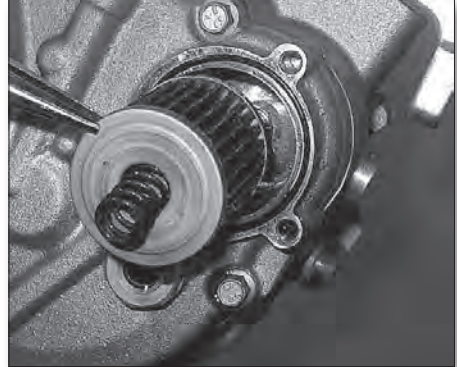

Refit the oil drainplug, tightening it to 20 Nm, and refill with 0.9 litres of engine oil (BARDHAL XTC60 15W50). Finally, tighten the oil filler plug (A) to 10 Nm.

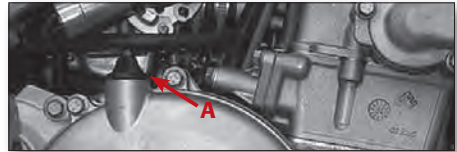

BRAKE MASTER CYLINDER FLUID

Front brake

Use the sight-glass (A) to check the brake fluid level. There must always be enough brake fluid for the level to be visible in the sight-glass. If there is not enough, the fluid must be brought up to the correct level. To do this, refill the reservoir by unscrewing the two screws (B), removing the filler cap (C) and topping up the fluid.

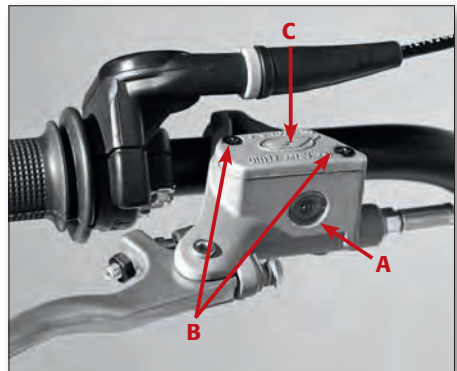

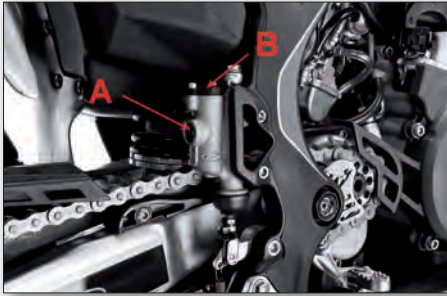

Warning

If you notice softness in the lever, there could be an air bubble in the system. In this case, bleed the rear brake system. Alternatively, contact your dealer immediately.

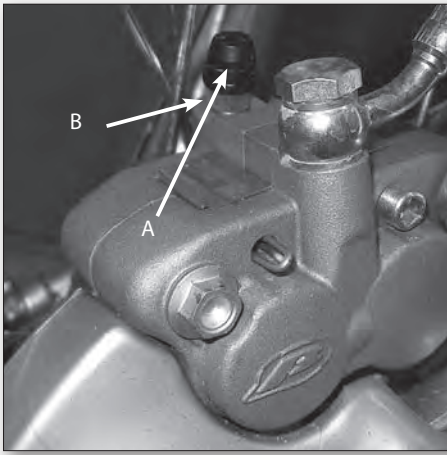

Rear brake

Check the level of the brake fluid through sight **A**. The level of the fluid should never fall below the mark in the sight. To restore the level of the brake fluid, unscrew cap **B** and pour in brake fluid (BARDAHL BRAKE FLUID DOT 4) until the level reaches the mark in sight **A**.

Note
For replacements, refer to the table on page 71, using the lubricants recommended on page 53.

BLEEDING THE FRONT BRAKE

To bleed the air from the front brake system, follow the steps below:

- Remove the rubber cap (A) from the bleed-nipple (B).

Take off the clutch fluid reservoir cover.

- Fit one end of a small transparent tube over the bleed-nipple (B), and insert the other end into a container.
- Pump 2/3 times with the lever and hold the lever in.
- Unscrew the bleed-nipple, allowing the fluid to flow through the tube.
- Reclose the bleed-nipple and release the lever.
- If you can see air bubbles through the tube, repeat the above operations until the fluid that comes out is free of air.

Note
During this operation it is important that you top up the master-cylinder reservoir continually, to compensate for the fluid which has been pumped out.

- Remove the small tube.
- Refit the rubber cap.

Note
Handle brake fluid with care: being corrosive, it can damage painted or plastic parts irreparably.

BLEEDING THE REAR BRAKE

To bleed the air from the rear brake system, follow the steps below:

- Remove the rubber cap C.
- Take off the clutch fluid reservoir cover.
- Fit one end of a small transparent tube over the bleed-nipple D, and insert the other end into a container.
- Pump 2/3 times with the brake pedal and hold the pedal down.
- Unscrew the bleed-nipple, allowing the fluid to flow through the tube.
- Reclose the bleed-nipple and release the pedal.
- If bubbles of air are visible through the tube, repeat the above operations until the fluid that comes out is free of air.

Note

During this operation it is important to top up the master-cylinder reservoir continually, to compensate for the fluid which has been pumped out.

- Remove the small tube.
- Refit the rubber cap.

Note

Handle brake fluid with care: being corrosive, it can damage painted or plastic parts irreparably.

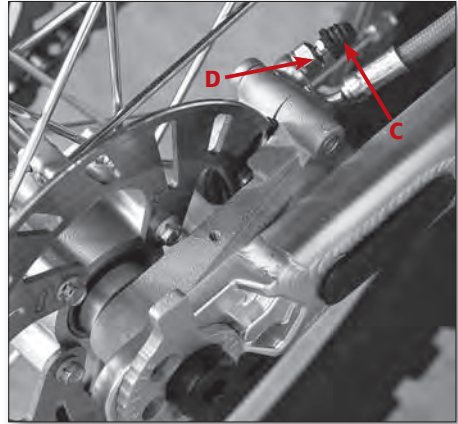

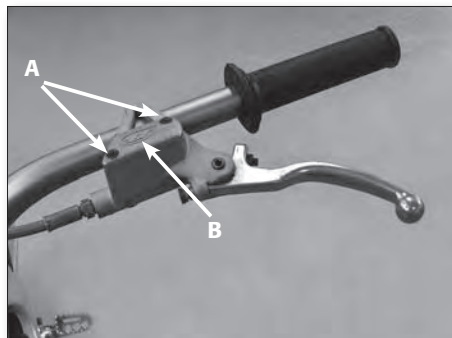

CLUTCH MASTER CYLINDER FLUID

Check the fluid in the reservoir. The level must never be below half-way up the reservoir. To bring the clutch fluid up to the correct level, refill the reservoir by unscrewing the two screws A, removing the filler cap B and topping up the fluid.

Note
Change the fluids in accordance with the intervals in the table on page 71, using the lubricants recommended on page 53.

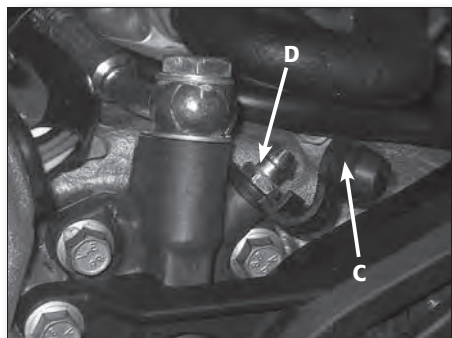

BLEEDING THE CLUTCH SYSTEM

To bleed the air from the clutch system, follow the steps below:

- Remove the rubber cap from the bleed-nipple C.
- Take off the clutch fluid reservoir cover.
- Fit one end of a small transparent tube over the bleed-nipple D, and insert the other end into a container.
- Pump 2/3 times with the lever and hold the lever down.
- Unscrew the bleed-nipple, allowing the fluid to flow through the tube.
- Reclose the bleed-nipple and release the lever.
- If you can see air bubbles through the tube, repeat the above operations until the fluid that comes out is free of air.

Note
During this operation it is important that you top up the master-cylinder reservoir continually, to compensate for the fluid which has been pumped out.

- Remove the small tube.
- Refit the rubber cap.

Note
Handle brake fluid with care: since it is corrosive, it can cause irreparable damage to painted or plastic parts

FORK OIL

Right fork leg

To change the fork oil, follow the steps below:

- 1 Take out the front wheel.
- 2 Remove the front mudguard.
- 3 Slack off the fork stanchion pinch bolts (A) and slide out the complete fork leg.
- 4 Unscrew the upper cap.
- 5 Unscrew the locknut securing the cap and remove it.
- 6 Undo the screw retaining the cartridge (located under the fork leg) and extract the cartridge.
- 7 Drain the fork leg and cartridge completely of oil.
- 8 Refit the cartridge to the fork leg, tightening the retaining bolt, then refill with oil (OJ01), thus charging the cartridge, up to the level shown in the diagram (with fork leg fully compressed).
- 9 Refit the cap to the damper rod, tighten the locknut, and screw the cap onto the stanchion, with the fork leg fully extended.
- 9 Replace everything, tightening the 5 screws (A) to 0.85 kgm.

Note

Recommended tightening torque 7.8: 9.1 Nm.

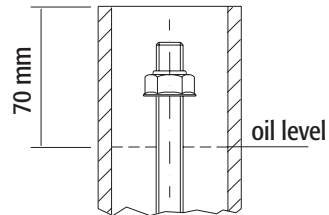
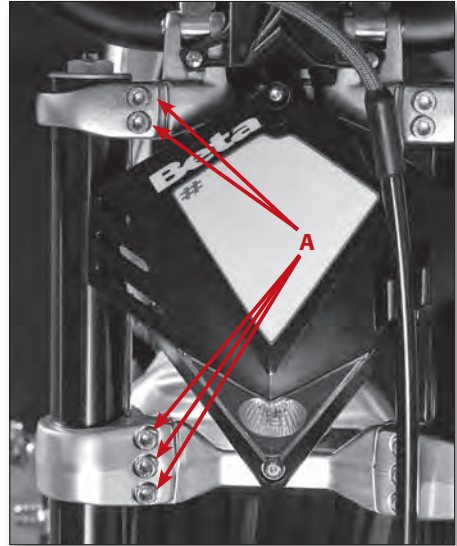

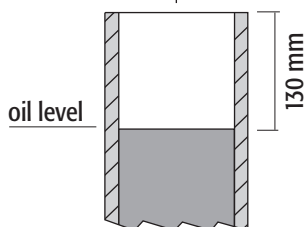
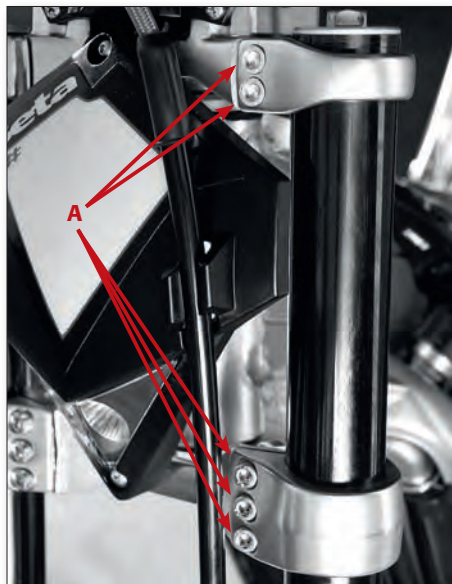

LEFT SHAFT

To replace the oil, proceed as follows:

1. Remove the front wheel.
2. Remove the front mudguard.
3. Loosen the shaft locking screws (A).
4. Unscrew the slider plug.
5. Remove the spacer and the spring, compress the fork to the end of the stroke, then empty out all the oil.
6. Add oil (OJ01), up to the level shown in the figure.
7. Reinsert the spring and the spacer then replace cap.
8. Put the shaft back on the fork triple clamps, tightening the screws (A) to 0.85 kgm.

Note

Change the fluids in accordance with the intervals in the table on page 71, using the lubricants recommended on page 53.

Check periodically and, if necessary, remove any residues of dirt that may remain between the fork seal and the dust cover, by removing the dust cover.

Note

Recommended tightening torque 7.8: 9.1 Nm.

SPARKPLUG

Keeping the sparkplug in good condition helps to reduce fuel consumption and keep the engine running optimally.

To check it, just pull off the plug cap and unscrew the sparkplug.

Check the gap between the electrodes with a feeler gauge: it should be 0.6-0.7 mm. If it is not within this range, you can adjust it by bending the negative electrode. Take care not to damage the central electrode.

Check also that there are no cracks in the in-

sulation or corroded electrodes. If you find either of these faults, replace the sparkplug immediately.

Check the sparkplug at the intervals given in the table on page

The best way to fit the sparkplug is to screw it in by hand until it will go no further, then lock it with a spanner.

Note

We recommend that you always use NGK CR7EB sparkplugs.

AIR FILTER

To access the filter, simply unscrew the 5 locking screws (A) of the rear mudguard, then proceed as follows:

1. Remove the mudguard by disconnecting the tail light cable.
2. Remove the filter frame and the filter by unscrewing the 2 screws (B).
3. Wash it with soap and water.
4. Dry it.
5. Moisten it with filter oil, removing any excess so that it does not drip.
6. If necessary, clean the inside of the filter box as well.
7. Proceed with reassembly. We recommend first assembling the frame on the filter.

Note

If the filter is very dirty, wash it first with petrol, then with shampoo and water.

If the filter is damaged, replace it immediately.

Caution

After every intervention, check that nothing has been left inside the filter box.

Clean the filter every time the vehicle is used off-road.

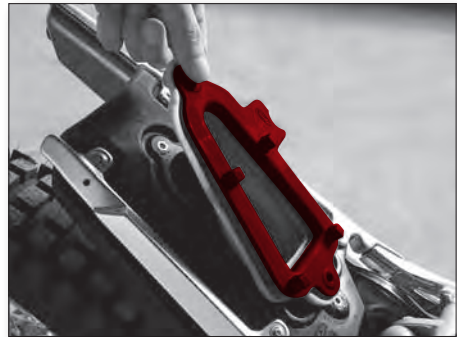
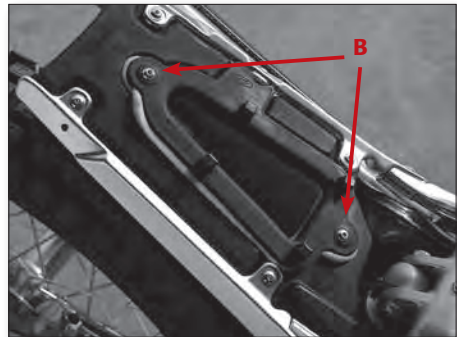
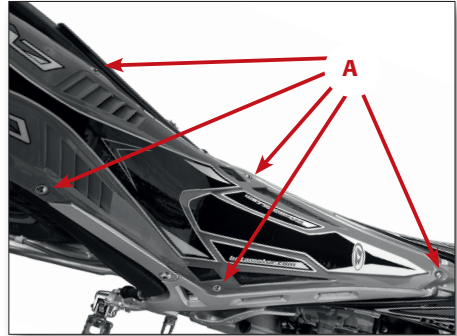



IGNITION GENERATOR CHECK

To check that the current generator is operating correctly, proceed as follows:

The check in question must be performed while the temperature of the component is approximately 20°C.

The check may also be performed with the generator mounted on the motorbike or on the engine.

Disconnect the black, 12-way connector between the generator and the CDI.

Disconnect the white, 2-way connector between the generator and the wiring.

Use a multimeter to check that the resistances read between the terminals shown below fall within the prescribed range:

BLACK-WHITE 320 ohm \pm 15%
(Pick-Up)

RED-BLUE 15 ohm \pm 15 %
(condenser charging)

YELLOW-YELLOW 0.6 ohm \pm 30%
(service power supply)

FRONT BRAKE

Check

To check the front brake wear, simply observe the caliper from the front, where it is possible to see the ends of the two pads where there should be a layer of lining which is at least 2 mm thick. If the layer is thinner, replace the pads immediately.

Note

Observe the times shown in the table on page 71. when performing the check.

Pad replacement

To replace the pads, proceed as follows:

1. Remove the disc cover and the caliper by unscrewing the two screws (A) and loosening screw B.
2. Take off split pin C.
3. Unscrew screw B.
4. Remove the pads (D) and replace them.
5. For reassembly, proceed in reverse order.

On the screws (A), it is advisable to use an appropriate medium resistance locking agent.

Note

Pay particular attention to the correct reassembly of the split pin in order to prevent braking problems.

If the brake disc is removed, apply the appropriate locking agent to the screws when reassembling.

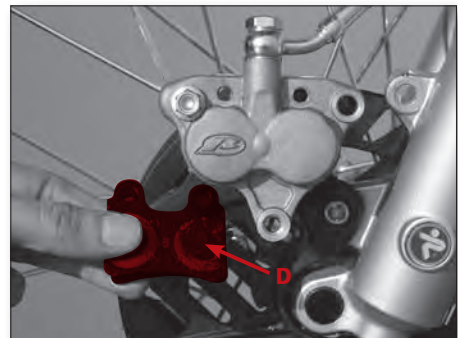
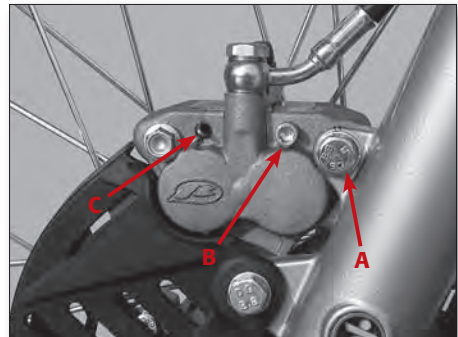

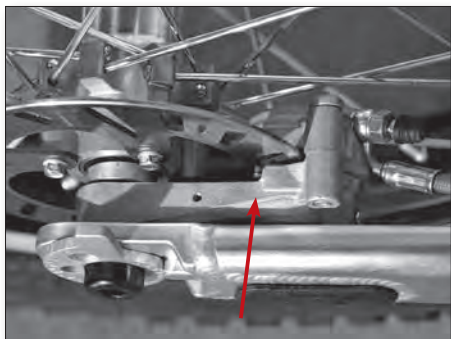

REAR BRAKE

Checking

To check the rear brake wear, simply observe the caliper from above, where it is possible to see the ends of the two pads where there should be a layer of lining which is at least 2 mm thick. If it is thinner than this, replace the pads immediately.

Note

Check the brakepads at the intervals given in the table on page 71.



Replacing the brakepads

To replace the pads, proceed as follows:

- Remove the wheel.
- Remove the caliper from the swingarm.
- Unscrew screw A.
- Remove the pads and replace them.
- For reassembly, proceed in reverse order. On screw A, it is advisable to use an appropriate medium resistance locking agent.

If the brake disc is removed, apply the appropriate locking agent to the screws when reassembling.

COOLANT

Check the level (this must be done with cold engine) as follows:

- Unscrew the filler cap (A) and visually check the fluid level.
- If the level is close to the bottom of the tube, add fluid as follows:
- Add the coolant to the system through the radiator.
- Undo screw (F) located on the left-hand side of the cylinder head until the coolant comes out of the bleed hole.
- Tighten the bleed screw and continue pouring the liquid into the radiator until it reaches the flared section in proximity to the filler cap.

The capacity of the circuit is given in the table on page 47. Use the fluids recommended in the table on page 53.

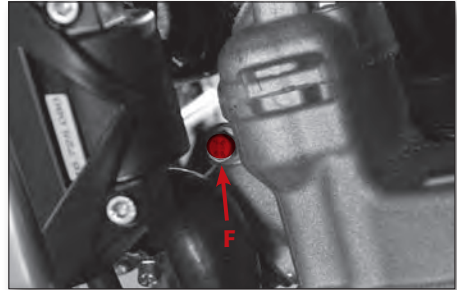
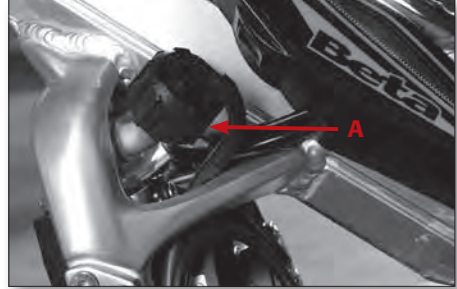

Caution

To prevent scalding, never unscrew the radiator filler cap when the engine is hot.

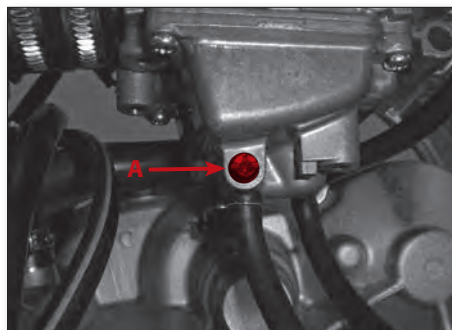
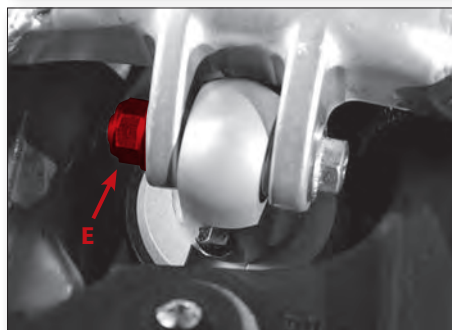
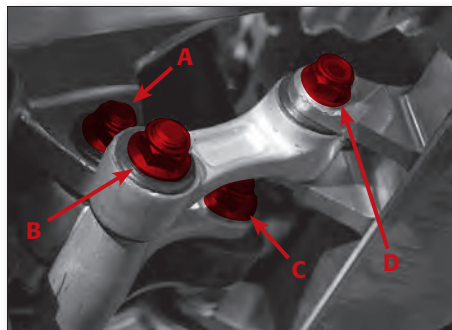

REAR SUSPENSION LINKAGE

To guarantee optimum operation and working life of the rear suspension progressive linkage, it is advisable to check that the nuts and bolts A, B, C, D and E are correctly tightened after every journey. Proceed as follows:

- Remove the linkage by unscrewing screws A, B, C, and D.
- Remove the bushings.
- Clean all the parts with a dry cloth.
- Lubricate the bearings and the bushings with lithium grease.
- Reassemble the unit, starting by securing the connecting-rods to the frame, using the bushings with an inner diameter of 8 mm and the special M screws.
- Secure the relay-arm to the swingarm, using the bushings with heads which are 2.5 mm thick and the M 10x75 screw, and to the shock absorber (M10x45 screw).
- Then mount the connecting rods on the relay arm using the remaining bushings and the M10x125 screw.

Note

The prescribed tightening torques are 4.5 kgm for screws A, B, C and E and 3.0 kgm for screw D.

CHECKS AFTER CLEANING

After cleaning the motorcycle, it is good practice to:

- Clean the air filter (proceed as described on page 65).
- Grease the drive chain.
- Remove any water inside the carburettor tank by unscrewing the screw positioned on the bottom of the carburettor float chamber

Note

This operation must be performed with the reserve valve closed.

SCHEDULED MAINTENANCE EVO 250 E 300 CC 4T

Item	end of running in (3h)	after the first 10h	every 30h	every 60h
Air filter	I - P	I - P	I - P	I - P
Spark plug	I	I	S	S
Petrol filter	I		I	I
Engine oil	S	I	S	S
Engine oil main filter	S		S	S
Engine oil mesh filters	P		P	P
Coolant	I	I	I	I
Brakes	I	I	I	S
Steering gear	I	I	I	I
Vehicle nuts and bolts*	I	I	I	I
Cylinder-Head nuts and bolts	I		I	I
Valve clearance	I			I
Piston rings				S
Piston				I - S

I - Inspection, checking tightening, replacement as required

P - Cleaning

S - Replacement

*** pay particular attention to the nuts and bolts securing the progressive leverage to the rear suspension.**

Chapter 4

Adjustments

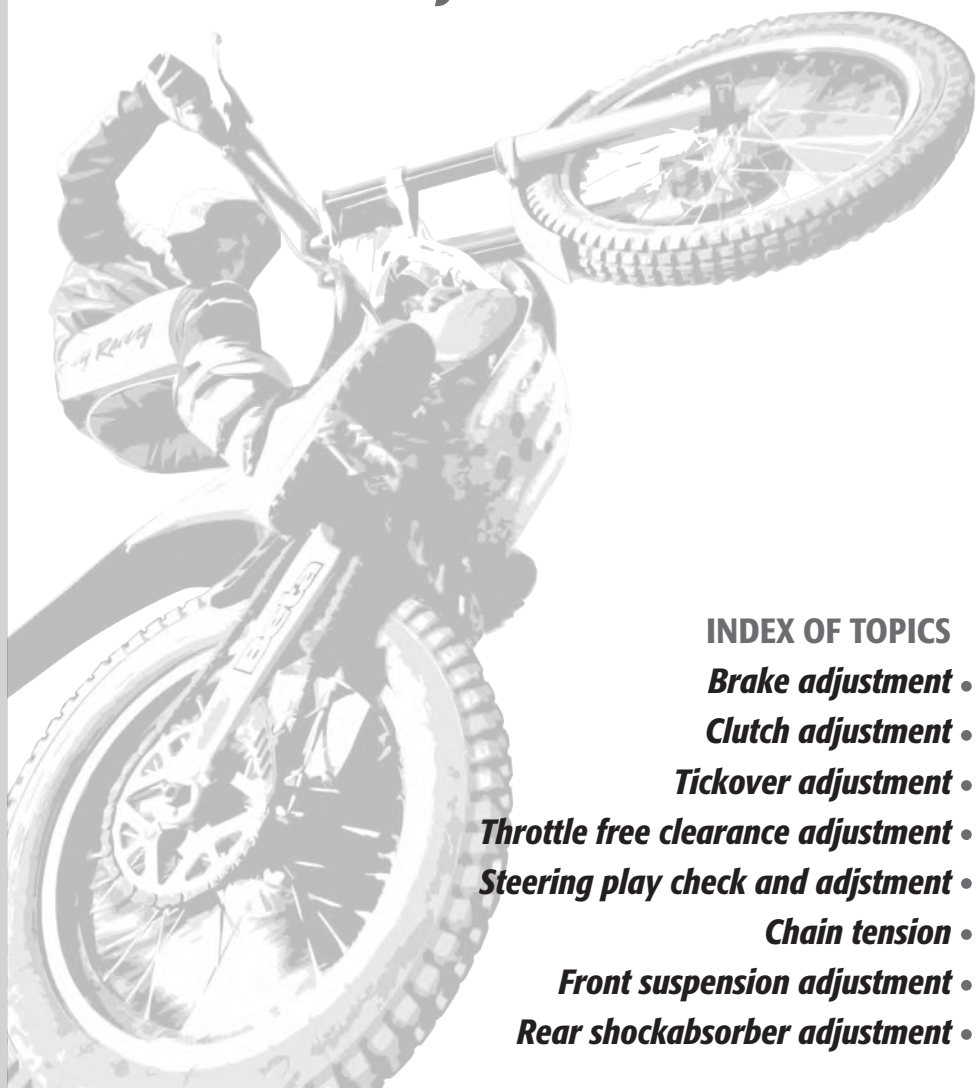

INDEX OF TOPICS

Brake adjustment •

Clutch adjustment •

Tickover adjustment •

Throttle free clearance adjustment •

Steering play check and adjustment •

Chain tension •

Front suspension adjustment •

Rear shock absorber adjustment •

BRAKE ADJUSTMENT

Front brake

The front brake is disc type with hydraulic control, and for this reason it requires only ordinary maintenance. If you wish to adjust the position of the lever, use adjuster screw A. It is advisable to leave a minimum of play.

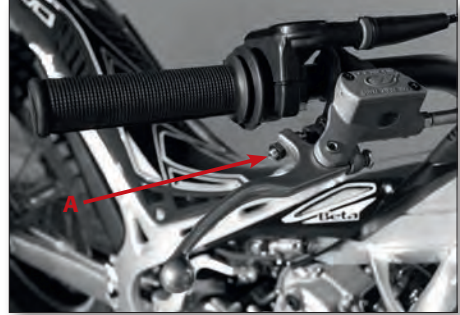

Rear brake

The rear brake is disc type with hydraulic control.

You can adjust the pedal height using adjusters B and C.

We recommend that you leave a minimum of free clearance.

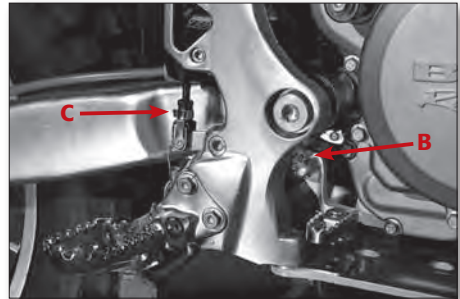

CLUTCH ADJUSTMENT

The only adjustment that can be made on the clutch adjusting the position of the clutch lever E.

To make this adjustment, use adjuster D.

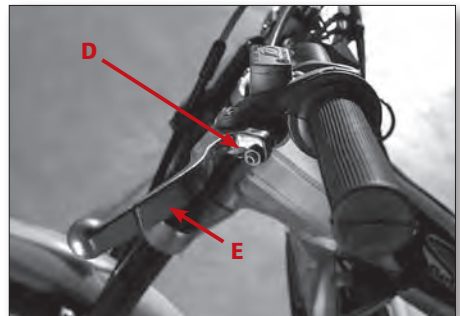

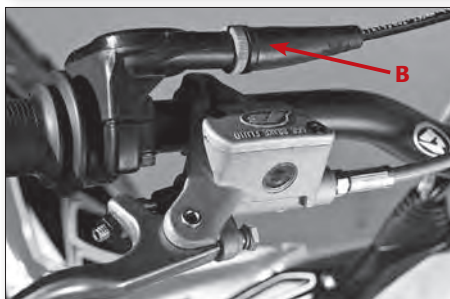
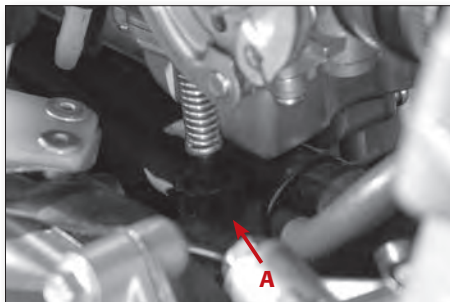

CARBURETTOR

Tickover adjustment

Tickover adjustment has a major influence on starting the engine. That is to say, an engine with a correctly adjusted tickover will be easier to start than an engine with incorrect tickover adjustment.

You adjust the tickover using the adjuster knob (A), which regulates the base position of the throttle valve.

Throttle free clearance adjustment

To adjust the tension of the throttle cable, use adjuster B. If this amount of adjustment is insufficient, use adjuster C (on the throttle cable itself).

CHECKING AND ADJUSTING STEERING CLEARANCE

Check the steering head tube clearance on a periodic basis, moving the forks backwards and forwards as shown in the figure. If a clearance is felt, adjust as follows:

- Remove the handlebar protection.
- Unscrew the two screws (C).
- Remove handlebar D.
- Loosen nut E.

- Loosen the screws (G) on the upper plate.
- Recover the clearance by intervening on ring nut F.
- Check that the rotation of the steering gear takes place in a fluent way. Excessive tightening of the steering gear bearings may jeopardise operation.
- Tighten nut E.

To re-secure, proceed in reverse order.

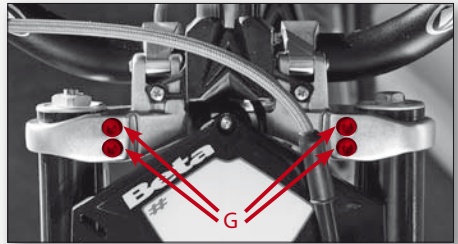
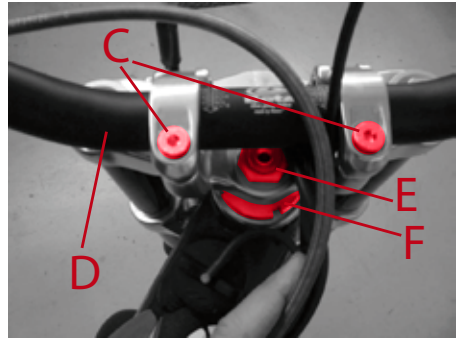

CHAIN TENSION

For a longer life of the final drive chain, we suggest you to check its tension periodically.

Always clean off dirt deposits and lubricate it. If the free clearance in the chain exceeds 20 mm, it needs tensioning as follows:

- Slack off nut A.
- Adjust with lever B.
- Adjust with the same lever on the opposite side, taking it to the same position.
- Check the wheel alignment.
- Re-tighten nut A.

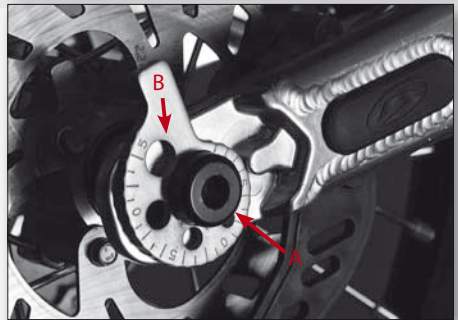
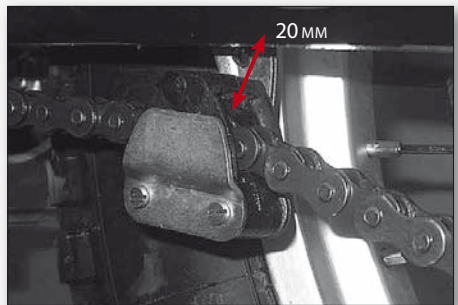

RIDER'S WEIGHT (Kg)	SPRING PRELOAD
peso > 80	+ 10 giri
75 < peso < 80	+ 5 giri
peso < 70	0

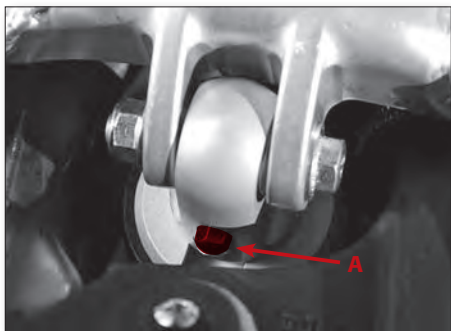
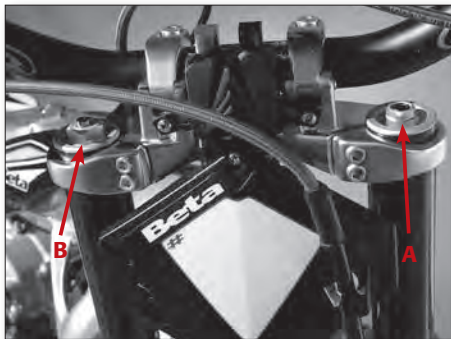

FRONT SUSPENSION ADJUSTMENT

Forks

- For a more reactive ride, unscrew adjuster knob B completely, with respect to the standard position.
- For a more controlled ride, preload the spring by about 4-5 turns, using screw A, and lock knob B 15 clicks from fully open (about mid-point in the range of adjustment).
- Rider's weight. Adjust to compensate for the rider's weight as follows.

In the event of any abnormality in operation, please contact our authorised service centres.

REAR SHOCKABSORBER ADJUSTMENT

Information on adjustment

- For a more reactive ride, back off the compression adjustment screw (A).
- For a more controlled ride, tighten the compression adjustment screw (A).

Note

For the standard adjustment, position the screw at +12 clicks from fully open.

Periodically clean the working area of the buffer as follows:

- Lower/remove the buffer, using a small screwdriver, and blow compressed air by means of the milling on the spring spacer.
- Always ensure that the progressive linkage bolts and the upper and lower shock absorber fixing bolts are correctly tightened.

Note

For correct tightening, refer to the "Rear Suspension Linkage" paragraph on page 70.

In the event of any abnormality in operation, please contact our authorised service centres.

Chapter 5

What to do in an emergency



PROBLEM	CAUSE	CURE
THE ENGINE WILL NOT START	Fuel feed system obstructed (pipes, fuel tank, tap)	Clean out the system
	Air filter excessively dirty	Follow procedure on page 65
	No current getting to the sparkplug	Clean or replace the sparkplug. If the problem persists, contact one of our dealers
	Engine flooded	With the throttle closed, active the Hot Start knob and operate the kick start lever repeatedly
	Drained floatbowl	Operate the manual tap as described on page 50
THE ENGINE MISFIRES	Sparkplug with incorrect electrode gap	Set the electrode gap correctly. See note on page 64
	Sparkplug dirty	Clean or replace the sparkplug
	Earthing fault	Check insulation at kill switch
POOR FRONT BRAKING	Pads worn, greasy or vitrified	Follow procedure on page 67
	Air or moisture in hydraulic circuit	Follow procedure on page 60
POOR REAR BRAKING	Pads worn, greasy or vitrified	Follow procedure on page 68
	Air or moisture in hydraulic circuit	Follow procedure on page 61