

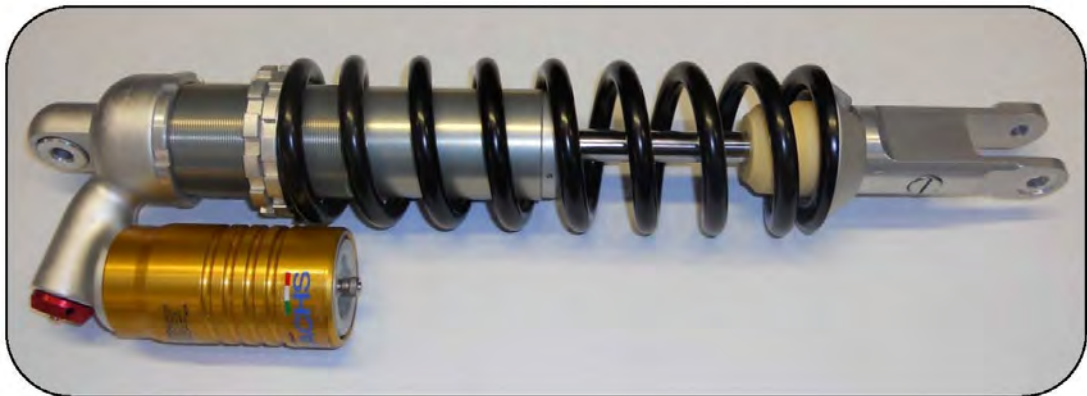

Sachs shock manual

(2013 –2015) 2 & 4 Stroke RR Enduro

(2014-2015) RS Dual Sport



Introduction

The procedures in this manual must take place in a clean environment using professional tools and some specific, being careful not to damage the surface of the shock, particularly the shaft. On the vise, always use protective jaws made from brass or aluminum. Always clean all parts before assembly, using lint free rags to prevent contamination that can impair function and durability. Always replace worn or damaged parts and gaskets and O-rings if they were removed.

Caution:

The incorrect disassembly and assembly of the shock or the use of non-original parts may cause malfunctions or serious risk to the safety of persons and property.

The shock absorber is filled with pressurized gas and oil, so disassembly done incorrectly may generate the projection of oil components causing serious injury to people who are in the immediate vicinity.

Therefore, before you perform any maintenance, be sure to read and carefully follow the instructions described in this manual.

Special tools

005299000088	spring preload spanner wrench
005299000087	shock base socket bushing
005299000090	shock body plastic jaws
005299000091	lower clevis socket Bushing
005299000091	brass shock shaft jaws
005299000092	piston sleeve
005299000093	shaft sleeve
PIA-0164-001-4	uniball tool
AVT-0127-002-T01-3	compression nut tool

Exploded view

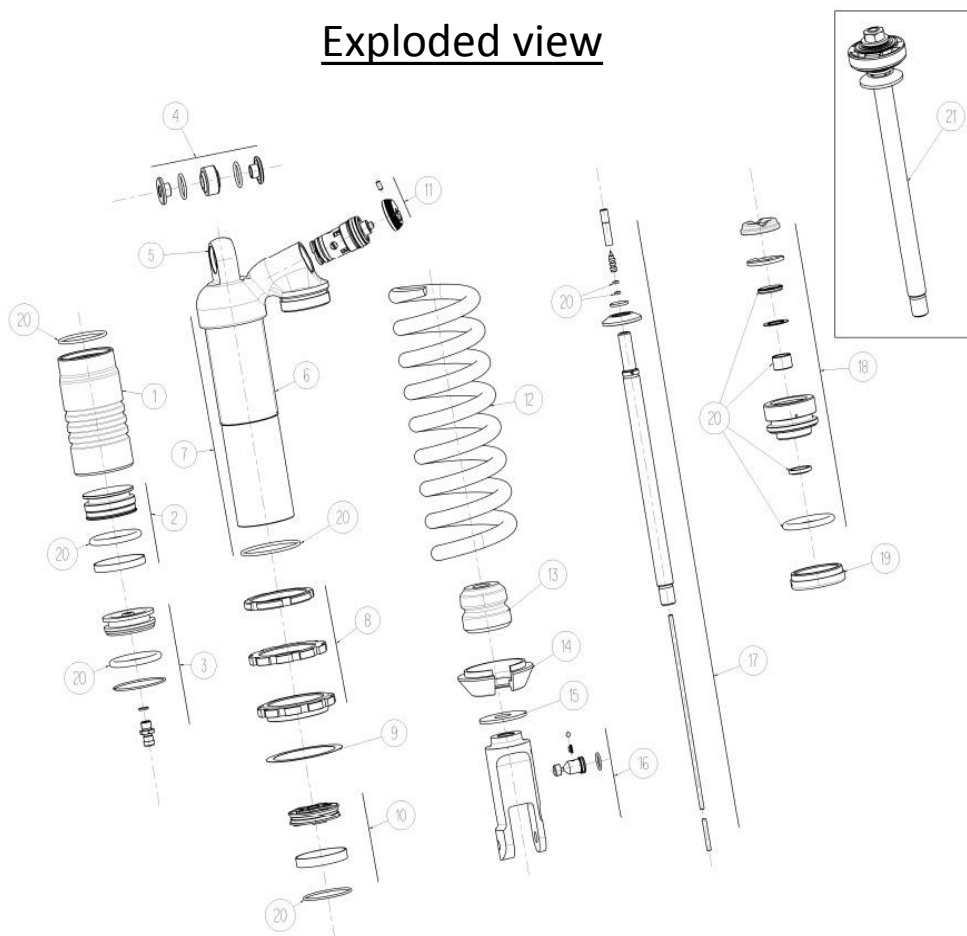

1) Reservoir	12) Spring
2) Diaphragm	13) Bumper
3) Reservoir cap	14) Collar
4) Uniball	15) Plastic Washer
5) Shock base	16) Clevis Complete
6) Shock body	17) Shaft Complete
7) Body complete	18) Shaft Guide
8) Spanner rings	19) Guide cap
9) Spring washer	20) Seals
10) Piston complete	21) Shaft complete
11) Compression circuit	

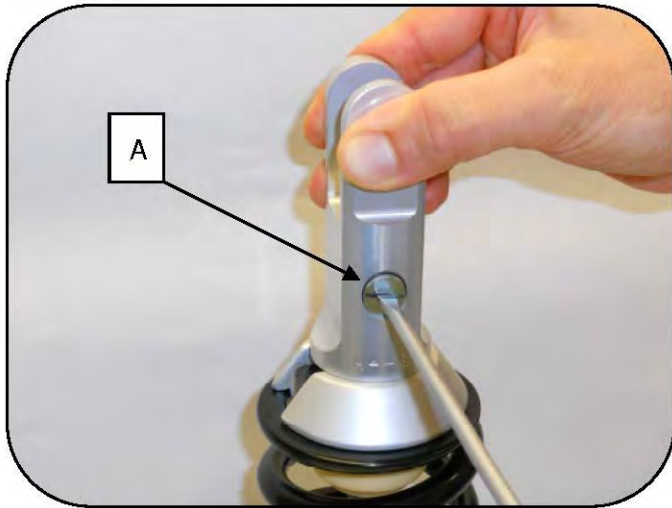

Check and record the location of the rebound adjustment. To do this, turn the dial clockwise until it stops, noting the number of “clicks” made by the dial (A). Then turn the dial counter clockwise until fully open.

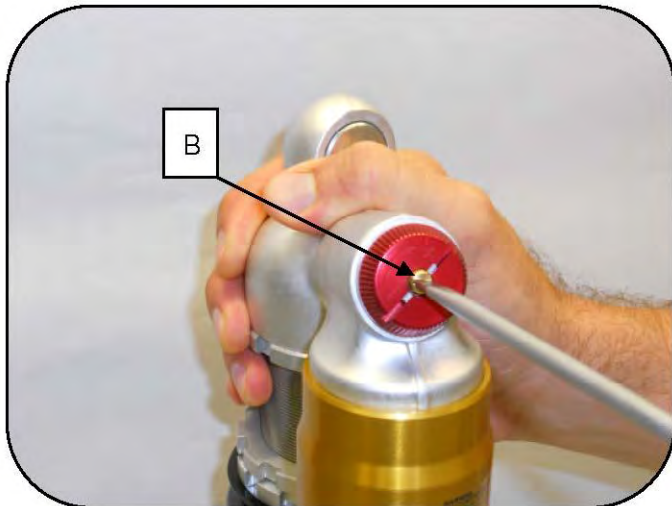

Check and record the position of the low speed compression dial adjustment. To do this, turn the dial (B) clockwise until it stops, noting the number of “clicks”. Then turn the dial counter clockwise until fully open.

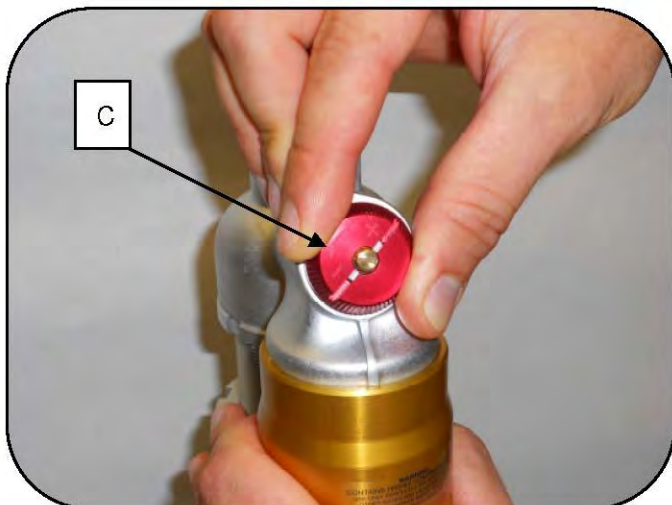

Check and record the position of the high speed compression dial (c). To do this, turn the dial in until it stops, noting the number of “clicks”. Then turn the dial counter clockwise until fully open.



Measure and record the length of the spring under preload.



Secure the shock in the vise upside down then remove the spanner rings using the preload spanner wrench (005299000087). This may require 2 wrenches, holding 1 ring while loosening the other.

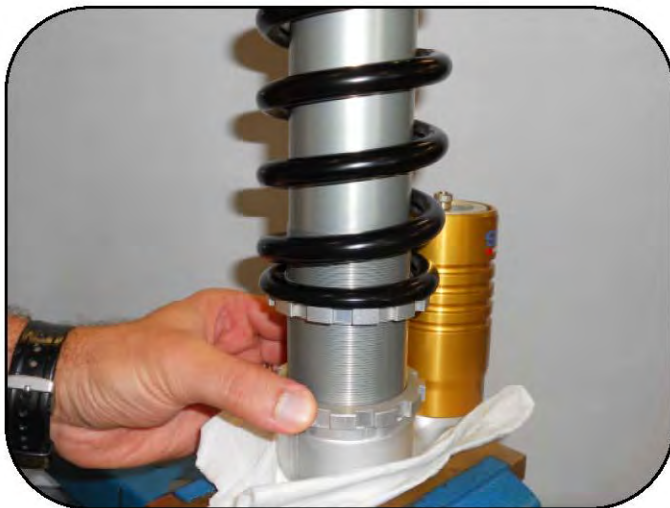

Screw the counter ring down towards the base to unload the rings.



Unscrew the next ring towards the base to completely remove the spring preload.



Unscrew the preload ring far enough to reveal the rubber bumper over the top of the spring.



Push down on the plastic washer and rubber bumper to make room to remove the spring collar.



With the rubber bumper out of the way, lower and slide out the spring support collar.



With the spring collar removed, you can now raise the spring off the shock.



Now that the spring is off the shock, remove the spring washer from the preload ring.

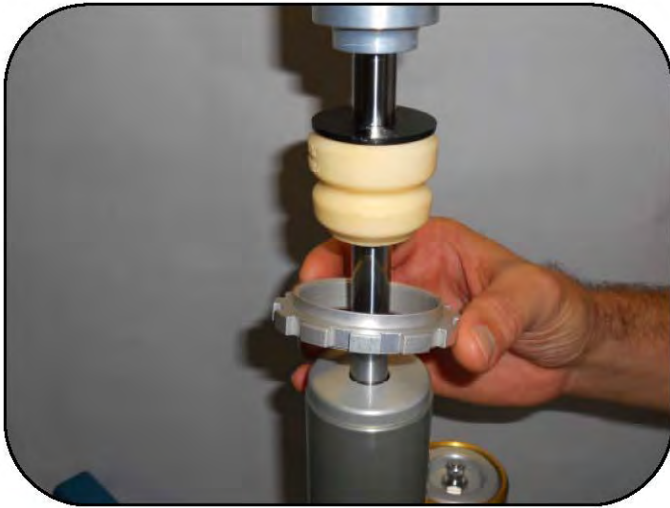

Remove the preload ring .



Remove the counter preload ring.



Insert the round end of a wrench or use a punch and lightly tap to raise an edge of the shock body cap.



Unscrew the cap from the reservoir valve.



Press the center of the valve to release all pressure from the tank.



Press down on the shaft guide to expose the snap ring.



With a screw driver , pry up on the snap ring being careful not to scratch the inner side of the shock body.



Remove the snap ring .



Pull up on the shaft to remove the damper assembly.

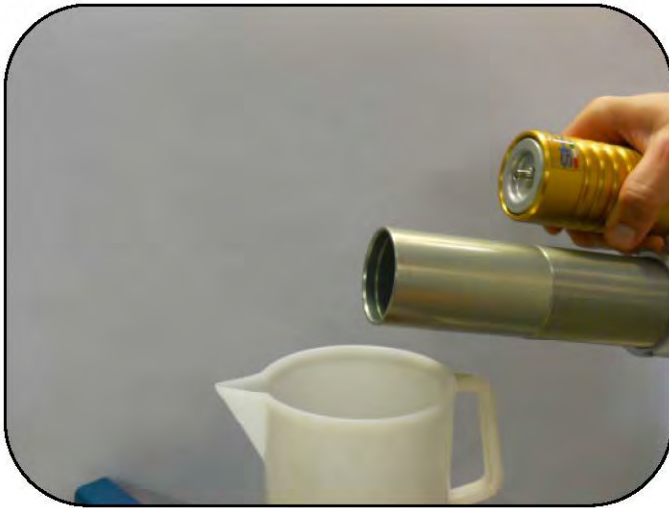

Drain the oil from the shock body.



Push down on the reservoir tank cap to expose the snap ring.



With a screw driver, pry up on the tank snap ring being careful not to scratch the inner side of the tank.



Screw the cap back on the tank valve.



Using pliers, pull up on the tank valve cap until it is removed from the tank.



Using reverse needle nose pliers or snap ring pliers, remove the separator diaphragm completely from the tank.



Drain the oil from the tank/shock body. Make sure it is drained completely. This can take a few minutes.



Use an Allen wrench to loosen the high speed compression dial lock nut.



Remove the high speed compression dial making sure not to loose the 2 bearings and 2 springs located underneath.



Remove the O-ring.



Remove the 2 bearings.



Remove the 2 springs from the same location.



Using the compression assembly nut tool (AVT-0127-002-T01-3) or round nose pliers, unscrew the compression adjuster assembly.



Remove the compression assembly



Remove the spring



Remove the spring guide bushing.



Remove the compression adjuster.



Remove the compression valve assembly.

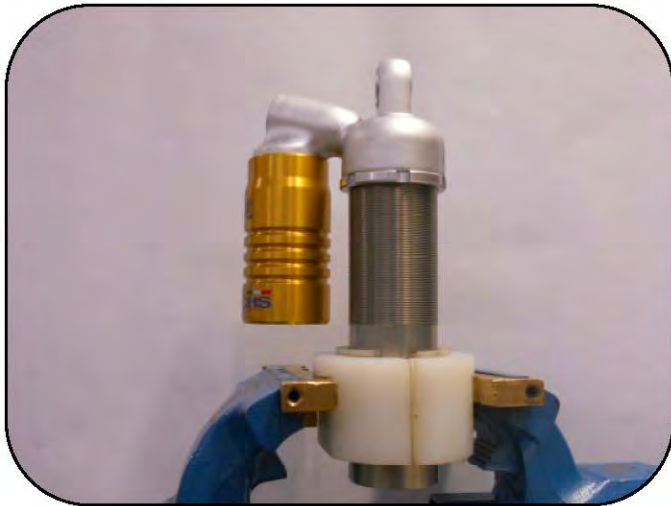

Using the plastic jaws (005299000089) secure the shock body in the vise.



Using a torch, heat the base locking ring.



Being careful that the base is hot, use the preload spanner wrench (005299000087) to loosen the base lock ring.



Lower the locking ring.



Heat the junction of the base and shock body with a torch.



Being careful that the base is hot, loosen the base from the shock body using the base socket bushing tool (005299000088)



Remove the base form the shock body.



Remove the locking ring.



Using the plastic jaws (0052990000898) to secure the reservoir tank, heat the base/tank junction with a torch.



Being careful that the base is hot, using the socket bushing tool (005299000088) loosen the base from the tank.



Remove the base from the tank.



Remove the O-ring from the tank side of the base.



Remove the O-ring from the other side of the base.

Removing the uniball



Lock the base in a vise at the end with the uniball. Using a center punch, through the bolt hole, tap on the lower flange bushing to remove it.



Flip the base over in the vise and repeat the procedure.



Note: The bushing will be removed along with an O-ring.

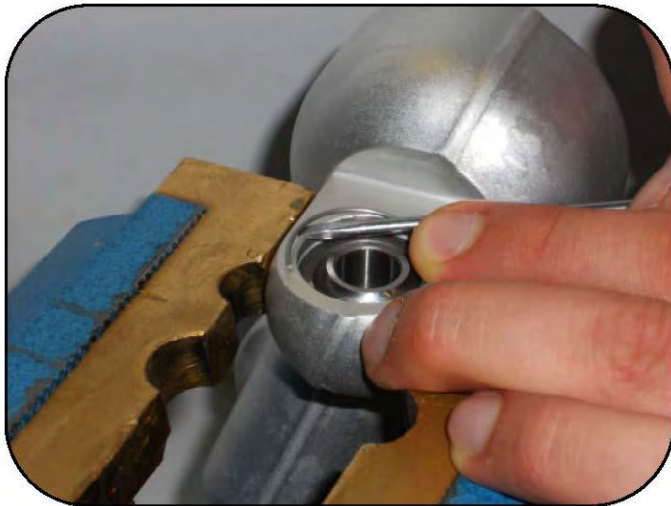

Remove the snap ring that holds the uniball.



Flip the base and secure in the vise. Using the correct size metal tool, tap out the uniball. Note: The uniball can only be removed from the side with the snap ring groove.

Removing the diaphragm



Remove the Teflon coated band from the diaphragm separator.



Remove the O-ring from the diaphragm separator.

Disassembly of the compression adjuster



Hold the assembly and with your thumbs, push on the center removing it from the housing .



Remove the compression adjuster.

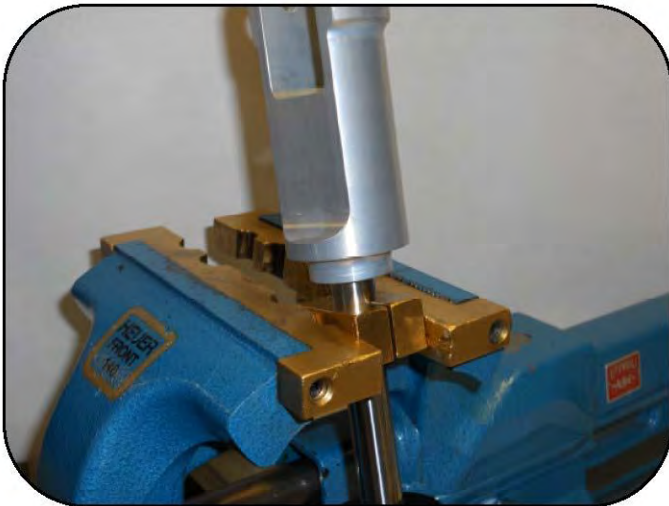

Lock the shaft into the vise using the brass shaft jaws (005299000091)

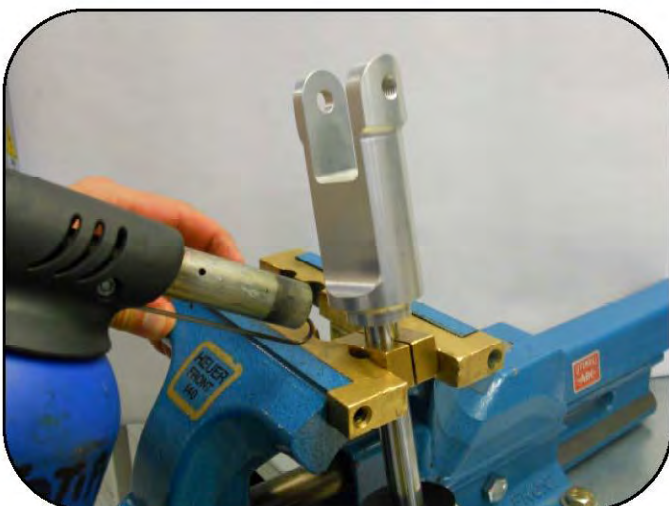

Heat the junction of the shock clevis and the shaft with a torch.

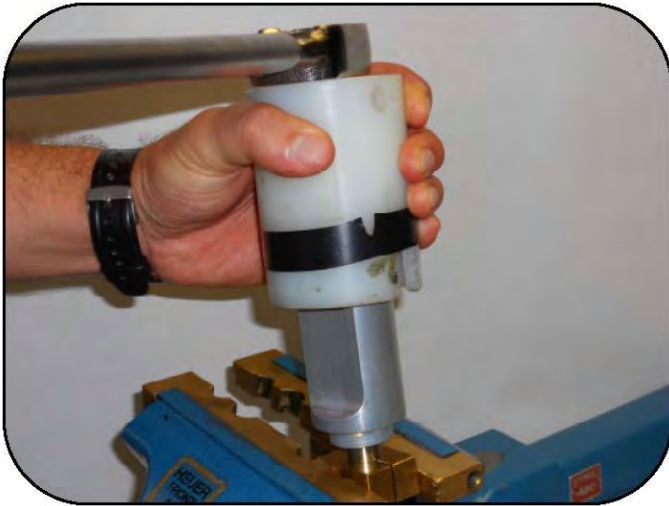

Being careful that the clevis is hot, loosen the clevis from the shaft using the clevis socket bushing tool (005299000090)

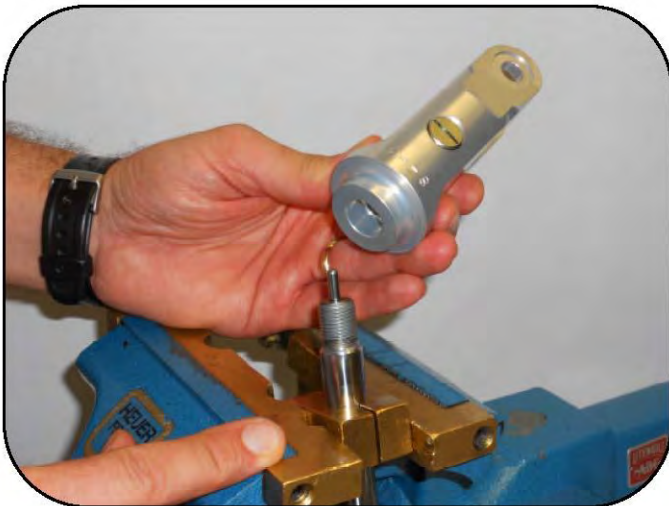

Remove the clevis from the shaft.

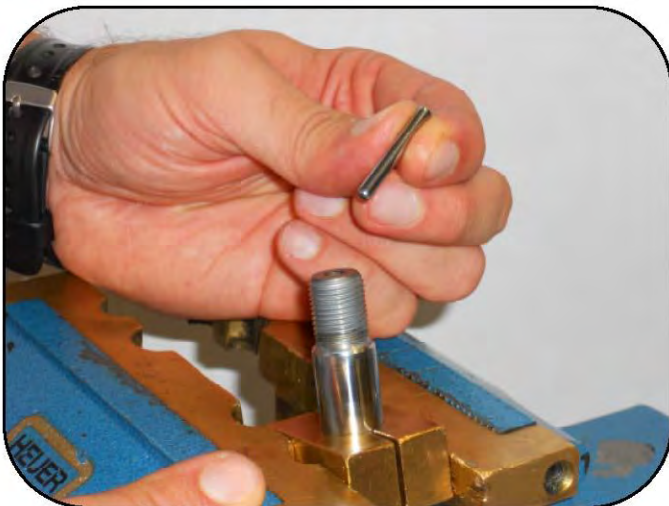

Remove the rebound regulating pin from the hole in the end of the shaft.



Remove the bumper plastic washer from the shaft.



Remove the bumper from the shaft.



Remove the body end cap from the shaft.



Remove the shaft guide .

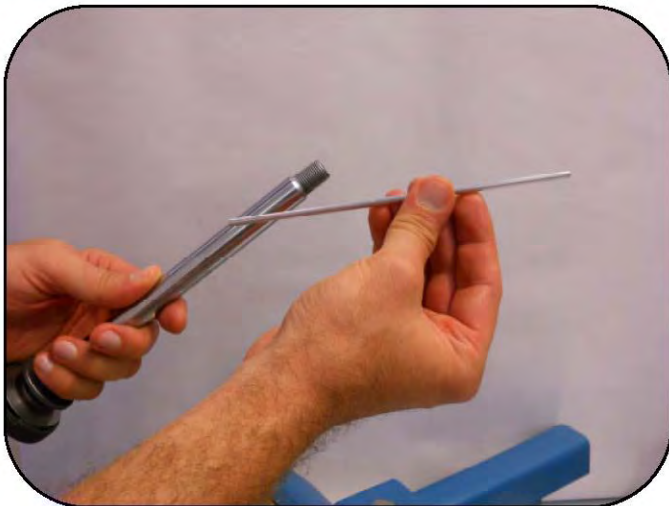

Remove the rebound adjuster rod from the hole in the end of the shaft.

Disassembling the piston



Secure the shaft in the vise using the brass shaft jaws (005299000091)



Loosen the nut on the piston assembly.



Remove the nut from the assembly.

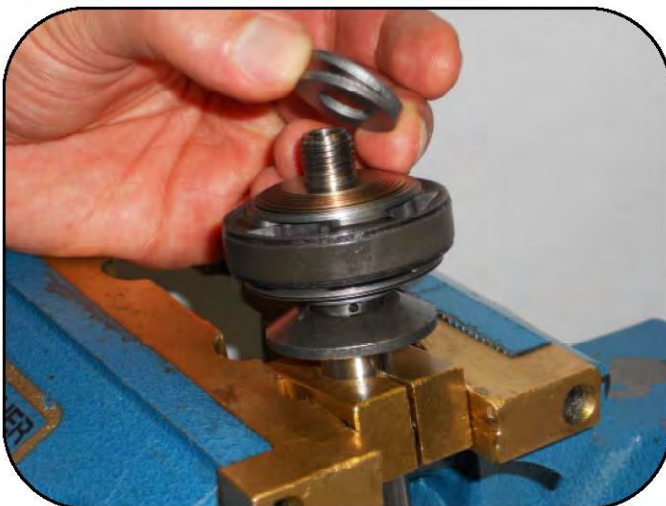

Remove the spacers.



Remove the rebound valve stack of shims.

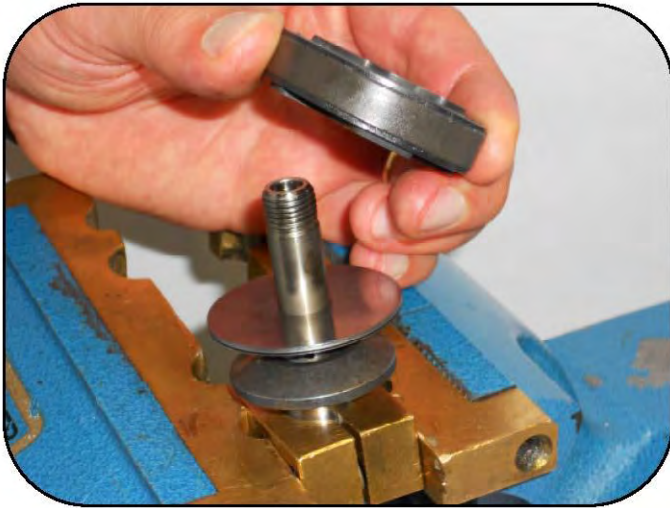

Remove the piston.



Remove the compression valve stack of shims.

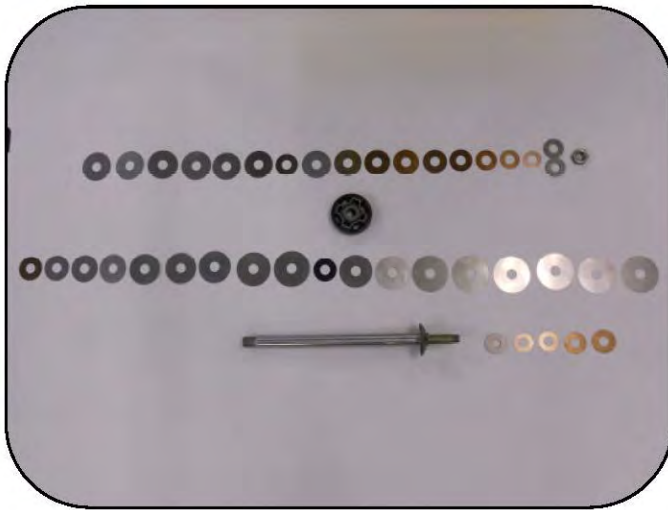

The valve calibrations are in a table on page 71 for the 2T and page 72 for the 4T.



Remove the O-ring from the tank cap.



Use a cutter to remove the Teflon band from the piston.

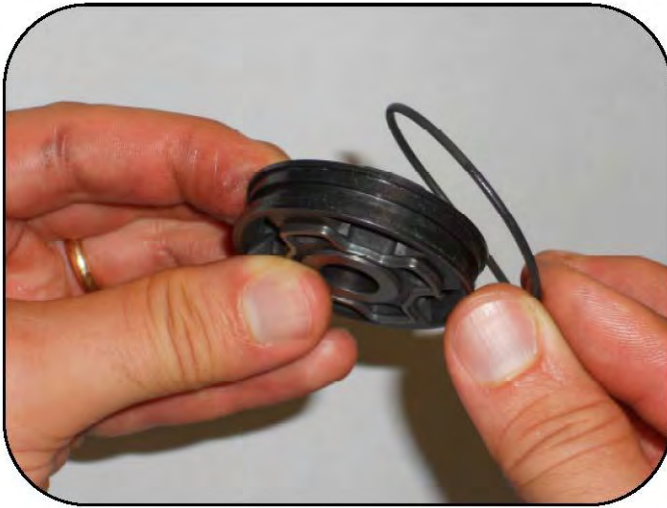

Remove the O-ring from the piston. Always replace the O-ring as it is always damaged from cutting off the Teflon band.

Removing the shaft guide



Pry off the rubber extension limiter from the shaft guide.



Remove the guide washer.



Remove the oil seal from the shaft guide.



Remove the oil seal support washer from the guide.



Remove the outer O-ring from the shaft guide.

Shock Assembly

Uniball Assembly



Make sure all parts are clean and free of debris.

Insert the tool (PIA-0164-001-4) into the uniball.



Place the uniball at the side of the base that has the snap ring groove.



Using a vise, press the uniball into the base from the side that has the snap ring groove.



Press the uniball into the base until it slightly touches the bottom of the seat.



Install the snap ring making sure it is seated the entire circumference of the groove.



Lightly grease both sides of the uniball.



Place the O-ring on the face of the uniball. The grease will help to hold the O-ring in place.



Insert the flange bushing using a bolt.



Place an O-ring on the other side of the uniball.



Insert the other Flange bushing on the bolt.

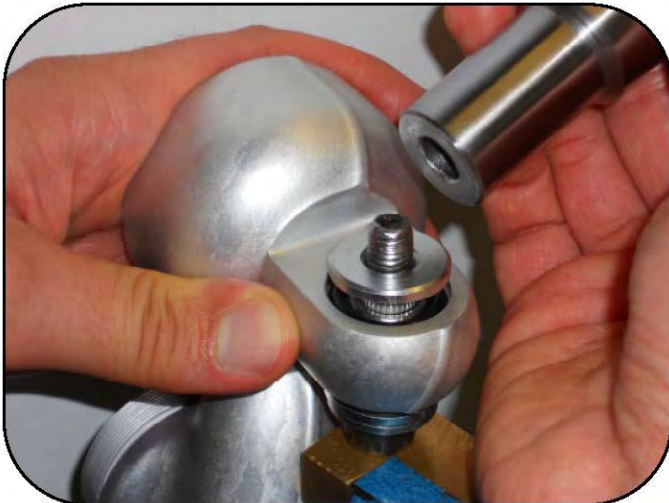

Resting the head of the bolt on the vise, place a metal sleeve over the bolt resting against the flange bushing.



Tap the sleeve with a hammer until the bushings are completely seated.



Insert the O-ring into the base, making sure it is seated completely.



Install the outer O-ring over the tank side of the base making sure it is fully seated.



Apply a light coating of rubber nitrile grease to the tank side O-ring.



Apply a medium strength thread locker to entire circumference on the threads of the tank side of the base.



Screw the tank onto the base.



Secure the tank in a vise using the shock body plastic jaws (00529000089) Tighten the base using the base socket bushing (00529000088) and torque to 50Nm.



Lightly grease the inner base O-ring area.



Apply a medium strength thread locker to the entire circumference of the inner threads of the base.



Screw the damper body to the base.



Secure the damper body to the vise using the plastic jaws (00529000089). Using the base socket bushing (00529000090) and a torque wrench, tighten to 150Nm.



Slide the base locking ring over the body and thread it down toward the base.



Apply a high strength thread locker to the external threads on the body near the base.



Tighten the lock ring on the base using your preload spanner wrench (00529000087)

Compression valve assembly



Lightly grease the O-ring on the compression valve assembly.



Place the compression valve assembly into the base opening noting the orientation in the photo.



Insert the spring guide bushing observing the orientation in the photo.



Place the conical spring in the opening with smaller diameter facing downwards.



Insert the compression adjuster observing the orientation in the photo.



Lightly grease the O-ring on the compression assembly.



Insert the compression assembly into the base.



Note that the square edges of the assembly fit into the grooves on the adjuster.

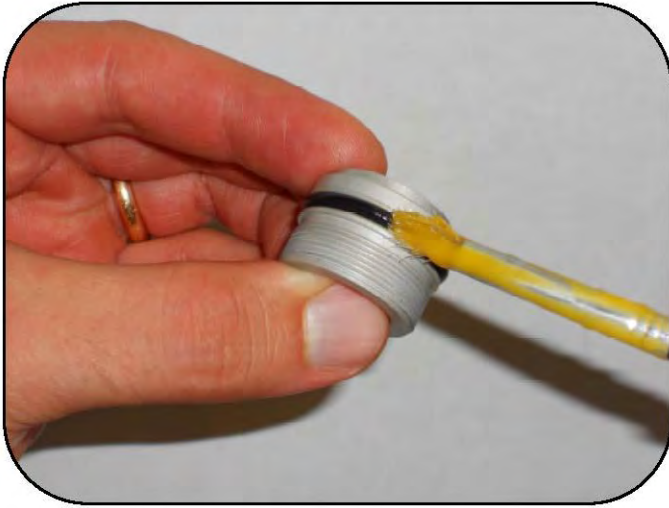

Lightly grease the O-ring on the outer edge of the compression housing.



Place the housing in it's seat on the base.

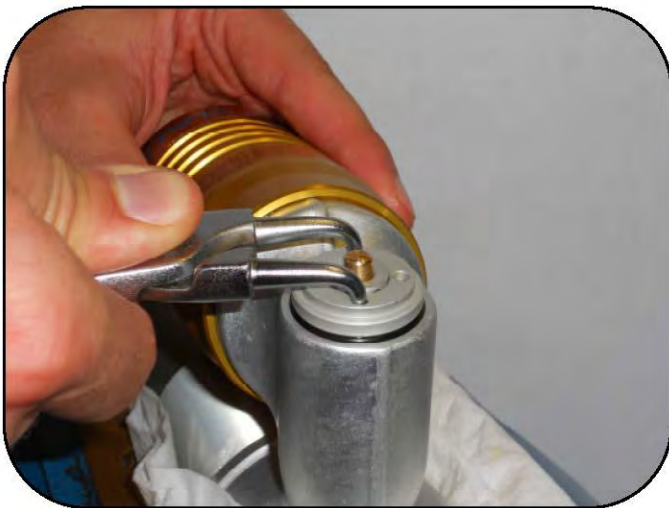

Screw in housing into seat.



Tighten the compression adjuster assembly with the proper tool (AVT-0127-002-T01-3) and torque to 14Nm.



Align the locking hole of the knob with one of the 4 holes on the compression assembly. Note the arrows in the photo.



Lightly grease 2 holes opposite each other perpendicular to the locking screw hole.

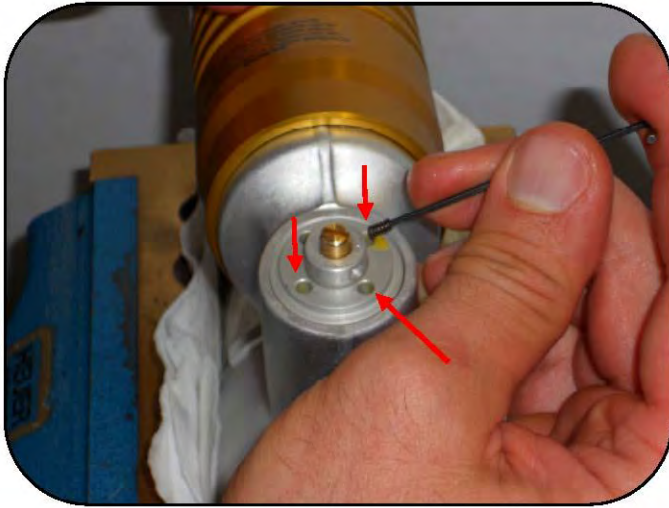

Insert the springs into the greased holes.



Insert the bearings into the holes with the springs.



Place the O-ring onto the compression assembly.



Place the compression adjuster knob on the assembly being sure to align the locking screw with the locking hole on the assembly.



Tighten the locking screw.

Piston Assembly



Install the piston O-ring using the piston sleeve (005299000092).



Install the piston Teflon band pushing down firmly using the piston sleeve (005299000092).



Lock the shaft into the vise using the brass jaws (005299000091), then install the calibrated compression shim stack.



Insert the piston on the shaft making sure the 4 square holes are facing downward.

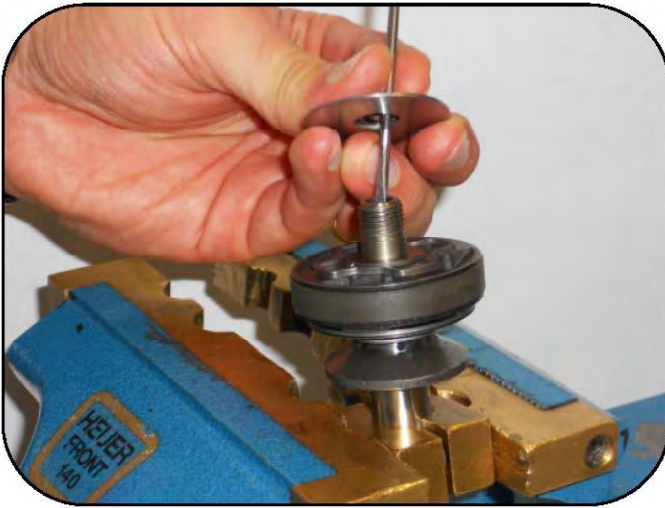

Install the calibrated rebound shim stack onto the shaft assembly.

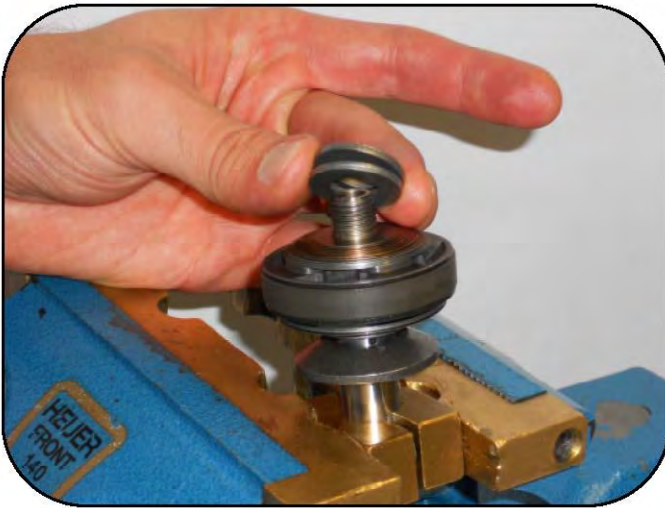

Place the 2 spacers onto the shaft.

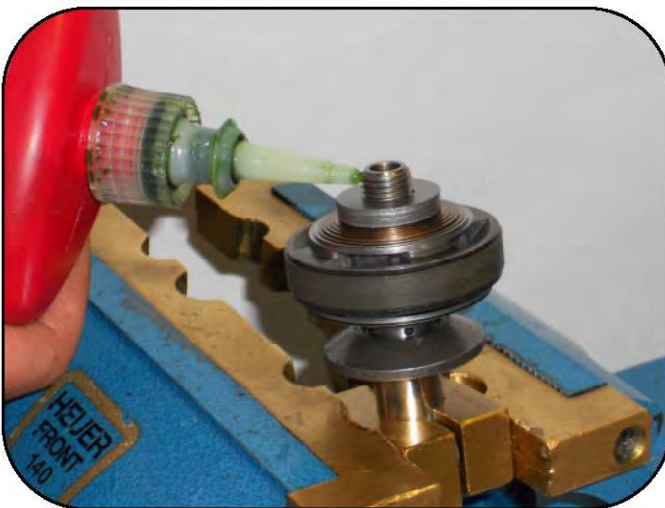

Put a drop of high strength thread locker onto the shaft threads.



Screw on the shaft nut.



Using a torque wrench, tighten the nut to 40Nm.

Shaft Guide Assembly



Place the oil seal support washer into the seat.

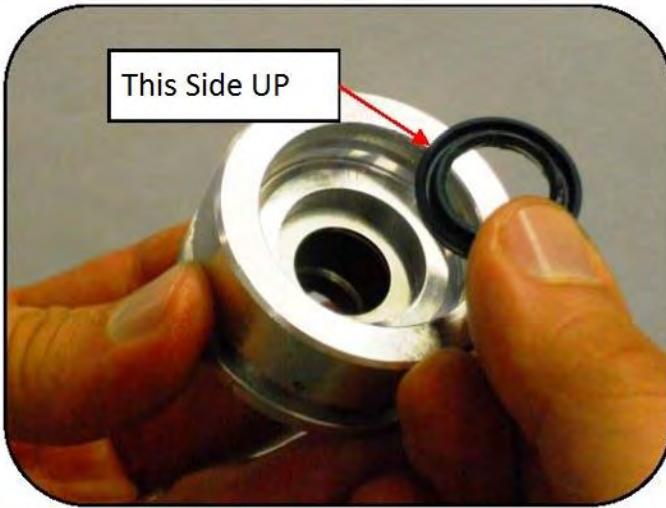

Insert the oil seal into it's seat with the grooved side facing up.



Insert the guide washer making sure the 4 grooves are facing down toward the seal.



Place the rubber extension limiter into the guide.



Install the outer shaft guide O-ring.



Grease the guide shaft seal circumference with Nitrile rubber O-ring grease .

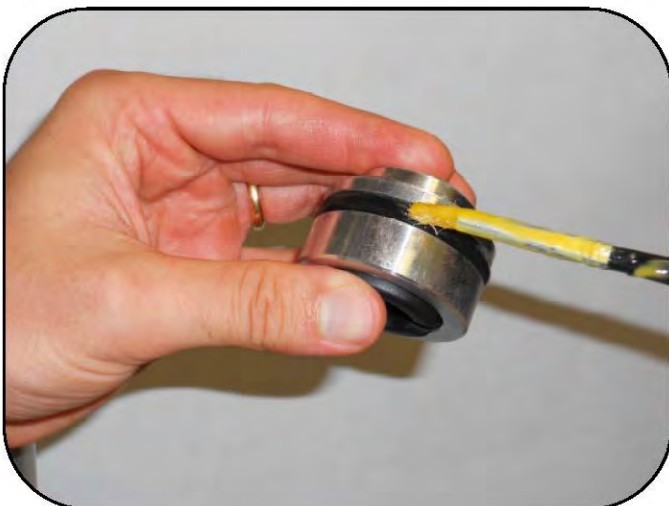

Using the same grease, apply to the entire circumference of the O-ring.

Reservoir Diaphragm Assembly



Install the outer diaphragm O-ring.

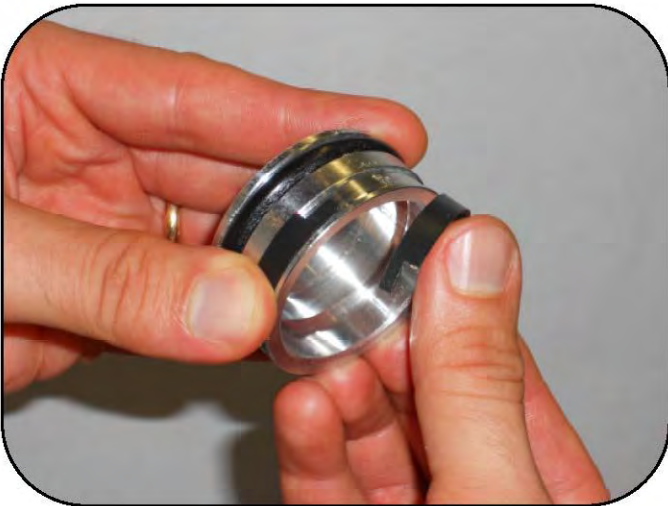

Install the Teflon band.



Using Nitrile O-ring grease, apply to the circumference of the O-ring.

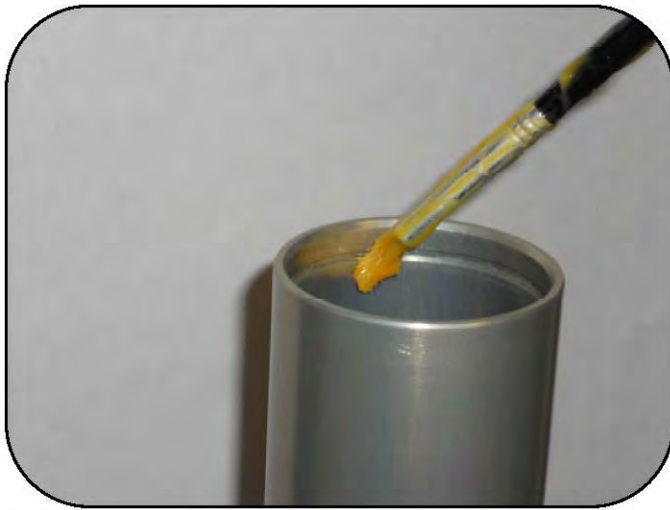

Grease the inner edge of the damper.



Insert the piston into the shock body.



Push the shaft in until it rests on the bottom of the shock body.



Secure the shock at it's base in a vise putting an absorbent rag between the jaws. Using Motul VI400 2.5-20W or an equivalent , fill the reservoir until it is flush with the edge.



Insert the diaphragm into the tank with the hollow side up.
Make sure a small amount of oil spills out until the O-ring is seated. This is to ensure there is no air trapped under the diaphragm.



Keeping the shaft seated, push the diaphragm in until it stops against the bottom of the tank.



Keeping the shaft seated, fill the body with oil.



Raise and lower the shaft a few times making sure the piston never leaves the oil. This will help to bleed out any air trapped below the piston.

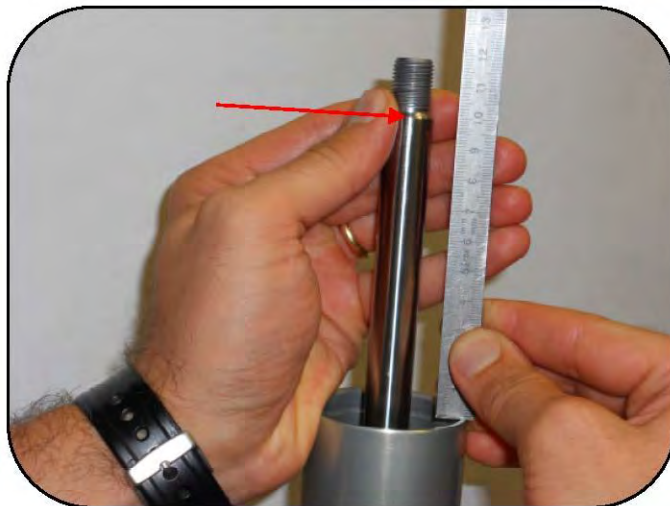

Position the shaft so the chamfer just below the threads is 100mm from the edge of the body.

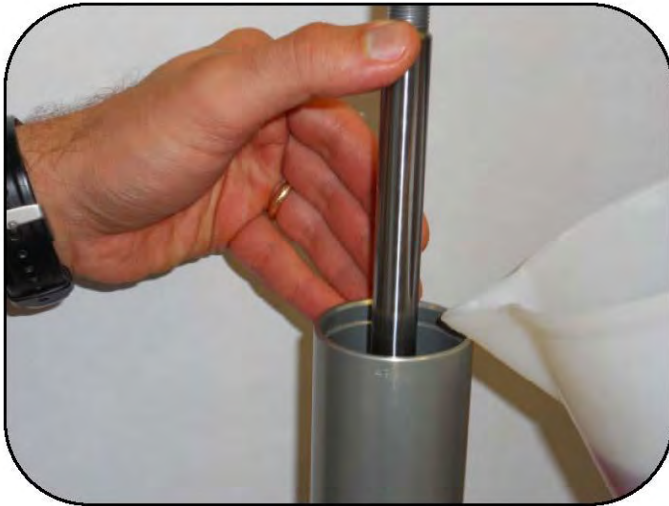

Keeping the shaft position fixed, fill the body with fluid until flush with the edge.



Apply the shaft sleeve to the end of the shaft. (005299000093)



Keeping the shaft position fixed, slide the guide onto the shaft observing the orientation in the photo. .



Keeping the shaft position fixed, slowly push the shaft guide into the body until the O-ring starts to seal. A small amount of oil will leak out and this will ensure no air bubbles are trapped under the guide.



After the outer diaphragm O-ring has entered the body and has sealed, continue to push the guide down far enough to expose the snap ring seat. At this point, the shaft position is no longer critical.



Insert the guide snap ring into the seat making sure it is installed completely.



Push the diaphragm all the way down, the shaft should rise.

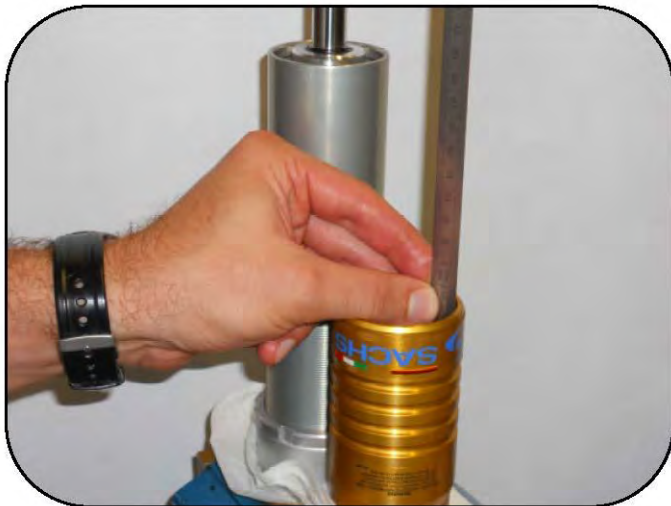

The diaphragm pushed all the way in should be 65mm measured from the edge of the tank .



Install the O-ring on the outer edge of the reservoir cap.



Grease the entire circumference of the O-ring.



Insert the cap into the tank.



Push the cap in enough to expose the snap ring seat.



Insert the clip into the seat making sure it is installed completely.



Push the shaft down until it stops.



While keeping the shaft pushed down, push on the gas valve to release any trapped air.



Pressure the tank with nitrogen to 130+/- 25 PSI for the 2T and 145+/- 25 PSI for the 4T.



Check the pressure with a reliable and calibrated gauge.



Screw the valve cap on and make sure it is tight.



Place the body cap on the shaft. To seat the cap, place it on the shock body and lightly tap around the circumference with a rubber mallet.

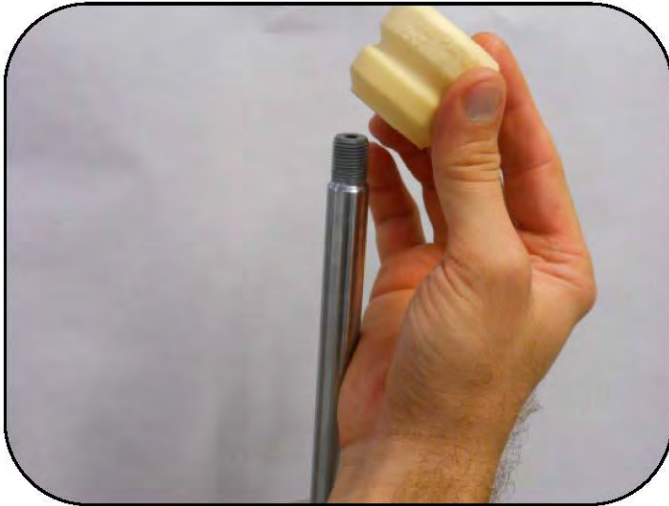

Install the bumper stop on the shaft.



Install the plastic washer.



Install the aluminum rebound adjustment rod.



Install the shorter steel adjustment rod.

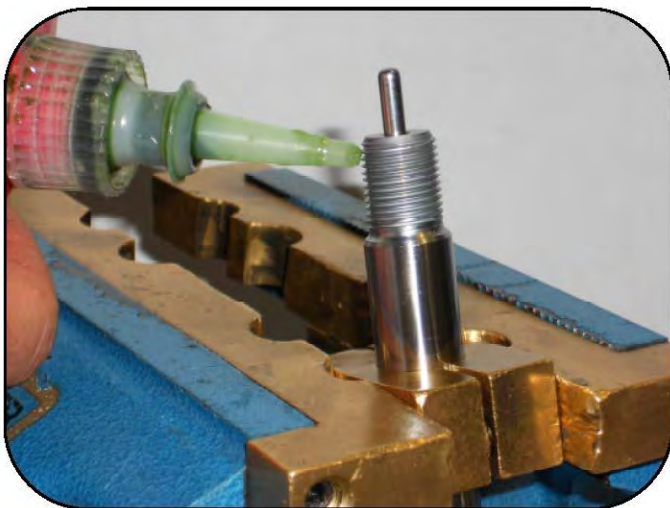

Apply a few drops of high strength thread locker to the shaft threads.

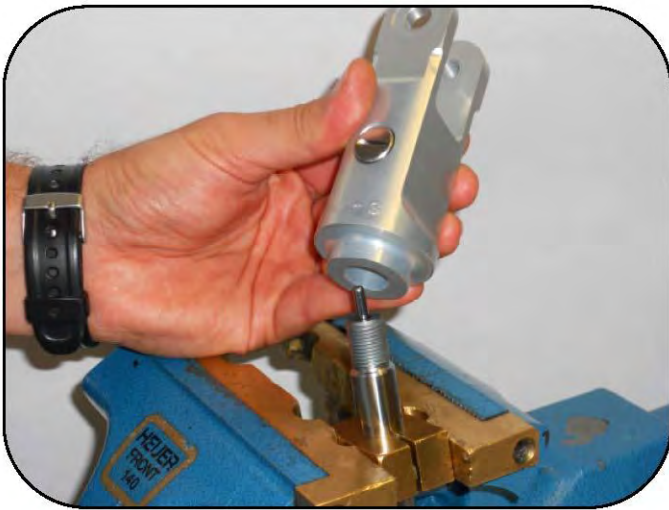

Install the shock clevis.



Tighten to 70Nm using the shock clevis socket bushing (005299000090) and a torque wrench.



Slide on the spring counter preload ring and screw it down toward the base.



Slide on the spring preload ring keeping the flange pointed up.



Slide on the spring support washer.

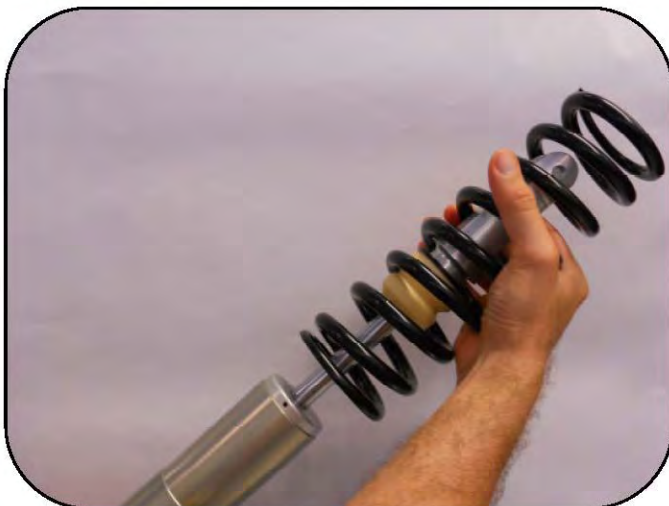

Slide the spring on the shock body.



Slide the plastic washer and bumper down to make room for the spring support collar.



Slide in the spring support collar and center it on the clevis.



Tighten the spring preload ring by hand and switch to the wrench (005299000087) when it starts to load.

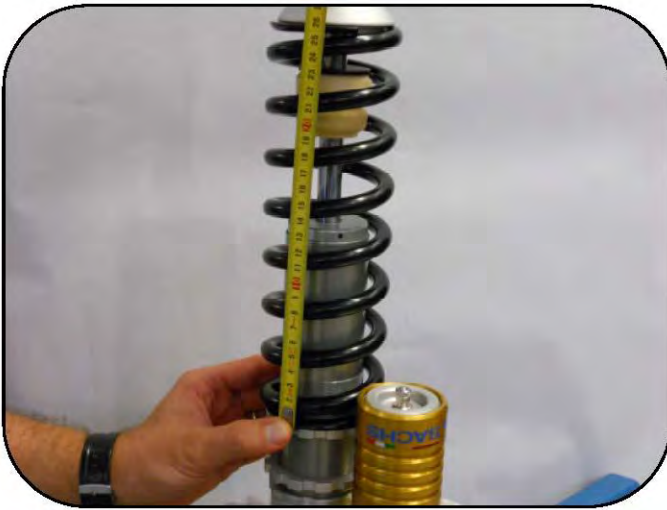

Tighten the spring preload ring until the spring is at the pre removal length.



Spin the spring counter preload ring up against the preload ring.



Using 2 wrenches (00529000087), tighten the preload ring against the counter preload ring.



Press the bumper against the collar.



Turn the high speed compression adjuster all the way in then back out to the pre removal setting.

The factory setting is:
20 clicks out on the 2T
22 clicks out on the 4T.



Turn the low speed adjuster all the way in and then back out the number of clicks recorded before removal.

The factory setting is:
20 clicks out on the 2T
22 clicks out on the 4T.



Turn the rebound adjusting screw all the way in then back out the number of clicks recorded before removal.

The factory setting is:

20 clicks out for the 2T

18 clicks out for the 4T.

Number of shims	Size
2	Ø24 x 2,00
1	Ø22 x 0,30
1	Ø24 x 0,25
1	Ø26 x 0,25
1	Ø28 x 0,25
1	Ø30 x 0,25
2	Ø32 x 0,25
1	Ø34 x 0,30
1	Ø36 x 0,30
1	Ø28 x 0,10
4	Ø38 x 0,20
3	Ø44 x 0,20
3	Ø44 x 0,15
2	Ø40 x 0,15
1	Ø28 x 0,15
1	Ø44 x 0,15
1	Ø42 x 0,15
1	Ø40 x 0,15
2	Ø38 x 0,15
1	Ø36 x 0,20
1	Ø34 x 0,20
1	Ø32 x 0,20
1	Ø30 x 0,25
1	Ø28 x 0,25
1	Ø26 x 0,25
1	Ø24 x 0,30
1	Ø23 x 0,30
1	Ø24 x 2,00

Shim stack for the 2 stroke

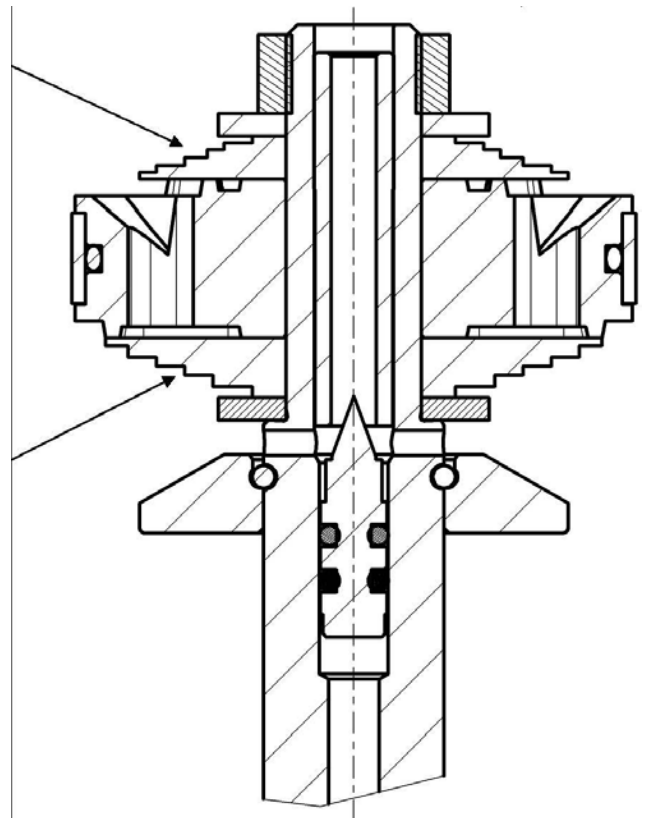

Number of shims

Size

- 1 Ø24 x 2,00
- 1 Ø20 x 0,30
- 1 Ø22 x 0,30
- 1 Ø24 x 0,25
- 1 Ø26 x 0,25
- 1 Ø28 x 0,25
- 1 Ø30 x 0,25
- 2 Ø32 x 0,25
- 1 Ø34 x 0,30
- 1 Ø36 x 0,30
- 1 Ø28 x 0,10
- 2 Ø36 x 0,15
- 6 Ø38 X 0,20

- 5 Ø44 x 0,20
- 3 Ø42 x 0,15
- 2 Ø40 x 0,15
- 1 Ø34 x 0,15
- 1 Ø44 x 0,15
- 1 Ø42 x 0,15
- 1 Ø40 x 0,15
- 2 Ø38 x 0,15
- 1 Ø36 x 0,20
- 1 Ø34 x 0,20
- 1 Ø32 x 0,20
- 1 Ø30 x 0,25
- 1 Ø28 x 0,25
- 1 Ø26 x 0,25
- 1 Ø24 x 0,25
- 1 Ø23 x 0,30
- 1 Ø24 x 2,00

Shim stack for the 4 stroke

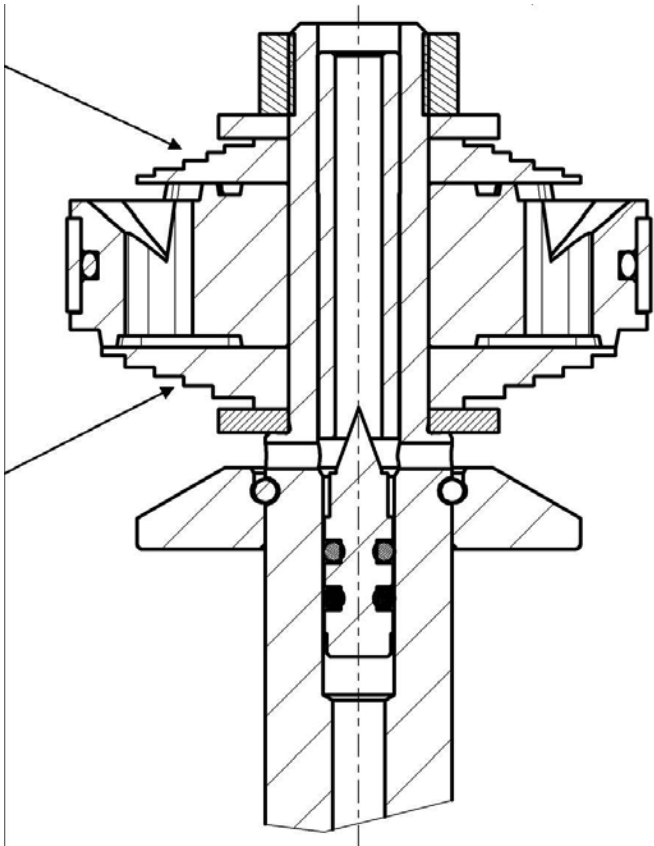

Table of torque values



Shock base to reservoir tank

50Nm



Shock base to shock body

150Nm



Compression adjuster assembly

14Nm



Shaft nut

40Nm



Shock clevis to shock shaft

70Nm

	2T	4T
Spring dimensions	Ø83x260	Ø83x260
Spring Rate	5.2	5.4
Shock oil	Fuchs Titan SAF 5045 EU 137 Red	
Installed spring length	253±1,5 mm	250±1,5 mm
Nitrogen pressure	9±1,8 bar	10±1,8 bar
Factory settings (Rebound)	-20 from fully closed ±2	-18 from fully closed ±2
Factory settings (Low speed compression)	-22 from fully closed ±2	-22 from fully closed ±2
Factory settings (High speed compression)	-20 from fully closed ±2	-22 from fully closed ±2